

RADIO CRAFT

RADIO TO THE MOON

SEE PAGE 464



In this issue—

The Oscilloscope
Vibrator Amplifier
Waves and Pulses

APR

1946

25¢

CANADA 30¢

RADIO-ELECTRONICS IN ALL ITS PHASES

From **VT FUZE**



National Carbon Co.

To **VEST POCKET RADIOS**

Actual Size
.01 MF-100 V



Solar's tiny TTR tubular paper capacitors were made by the MILLIONS for Navy "Secret Project A"—the VT radio proximity fuze for shells and bombs. Ultra-compact and ultra-reliable, these resin-protected capacitors filled the nation's needs in an application where failure could not be tolerated.

Production efficiency and high standards of quality-control won a special award of the Navy Ordnance "E" for Solar's Bayonne and Chicago plants.

Today, the same production facilities and skilled personnel that turned out these exceptionally small tubulars for the national defense are already supplying them for the Vest Pocket and Purse-Sized Radios and Hearing Aids of Tomorrow.

In applications where space and weight are all-important, the TTR tiny tubular or its flat counterpart TTF, is the answer to your needs.

These midget units are just another example of the combination of research facilities, engineering know-how and production capacity which has made Solar the logical supply source of industry for paper, electrolytic and mica capacitors.

Ⓢ 1015



Bayonne, N. J. and Chicago, Ill.

SOLAR CAPACITOR SALES CORPORATION
285 Madison Avenue, New York 17, N.Y.





**Building this
A. M. SIGNAL GENERATOR**
gives you valuable experience. Provides amplitude-modulated signals for test and experiment purposes.



RADIO SERVICING
pays many good money for full time work. Many others make \$5, \$10 a week EXTRA fixing Radios in spare time.

Learn RADIO by PRACTICING in Spare Time

with 6 Big Kits of Radio Parts I Send You

Let me send you facts about rich opportunities in Radio. See how knowing Radio can give you security, a prosperous future. Send the coupon for FREE 64-page book, "Win Rich Rewards in Radio." Read how N. R. I. trains you at home. Read how you practice building, testing, repairing Radios with SIX BIG KITS of Radio parts I send you.

Future for Trained Men Is Bright in Radio, Television, Electronics

The Radio Repair business is booming NOW. There is good money fixing Radios in your spare time or own full time business. Trained Radio Technicians also find wide-open opportunities in Police, Aviation, Marine Radio, in Broadcasting, Radio Manufacturing, Public Address work, etc. Think of the boom coming now that new Radios can be made! Think of even greater opportunities when Television and Electronics are available to the public!

Many Beginners Soon Make \$5, \$10 a Week EXTRA in Spare Time

The day you enroll I start sending EXTRA MONEY JOB SHEETS to help you make EXTRA money fixing Radios in spare time while learning. You LEARN Radio principles from my easy-to-grasp Lessons—PRACTICE what you learn building real Radio Circuits with Radio parts I send—USE your knowledge to make EXTRA money in spare time.

Mail Coupon for Free Copy of Lesson and 64-page Illustrated Book

I will send you FREE a sample lesson, "Getting Acquainted with Receiver Servicing," to show you how practical it is to train for Radio in spare time. With it I'll send my 64-page, illustrated book, "Win Rich Rewards in Radio." Just mail coupon in an envelope or paste it on a penny postal. J. E. Smith, President, Dept. 6DX, National Radio Institute, Pioneer Home Study Radio School, Washington 9, D. C.

My Course Includes Training in
TELEVISION--ELECTRONICS

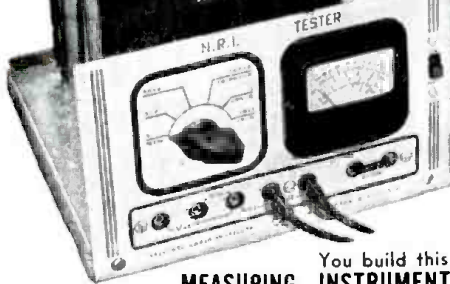

You build this
MEASURING INSTRUMENT
yourself early in the course—use it for practical Radio work on neighborhood Ramoney!

You build this
SUPERHETERODYNE CIRCUIT
That brings in local and distant stations. You get practical experience putting this set through fascinating tests.

**BE A SUCCESS in RADIO
I Will Train You at Home**

Sample Lesson FREE



Gives hints on Receiver Servicing, Locating Defects, Repair of Loudspeakers, I.F. Transformer, Gang Tuner, Condenser, etc., 31 illustrations. Study it—keep it—use it—without obligation! Mail coupon NOW for your copy!



**GET BOTH 64 PAGE BOOK
SAMPLE LESSON FREE**

**MR. J. E. SMITH, President, Dept. 6DX
NATIONAL RADIO INSTITUTE, Washington 9, D. C.**

Mail me FREE, without obligation. Sample Lesson and 64-page book, about how to win success in Radio and Television—Electronics. (No Salesman will call. Please write plainly.)

Age

Name

Address

City Zone State 4FR

If you are a war veteran, check here.



A powerful display...



RAYTHEON
Bonded
ELECTRONIC
TECHNICIANS

THIS RADIO REPAIR SHOP IS BONDED, BY WESTERN NATIONAL INDEMNITY CO., TO:

- 1** Guarantee all radio repair work for 90 days.
- 2** Use only parts of recognized quality.
- 3** Charge not over established prices for parts.
- 4** Test customers' tubes as accurately as possible.
- 5** Keep labor charges at a reasonable level.
- 6** Perform only such work as is necessary.
- 7** Maintain the highest quality service.
- 8** Maintain proper equipment for good repair work.



...to KEEP CUSTOMERS COMING!



Excellence in Electronics
RADIO RECEIVING TUBE DIVISION
NEWTON, MASS. • NEW YORK • CHICAGO



Bringing radio repairing right out in the open for all your customers, this Raytheon Bonded Electronic Technician display tells them exactly how you operate in *their* interest. And that means *profitable* repeat business.

This is only one of many ways your prospects and patrons will learn to identify your shop with fair prices, quality work and guaranteed reliability. Find out how you can qualify to become a Bonded Electronic Technician. Bonded service means better customer relations. For full details, see your Raytheon distributor today.

ANOTHER REASON WHY IT PAYS TO QUALIFY AS A RAYTHEON BONDED ELECTRONIC TECHNICIAN

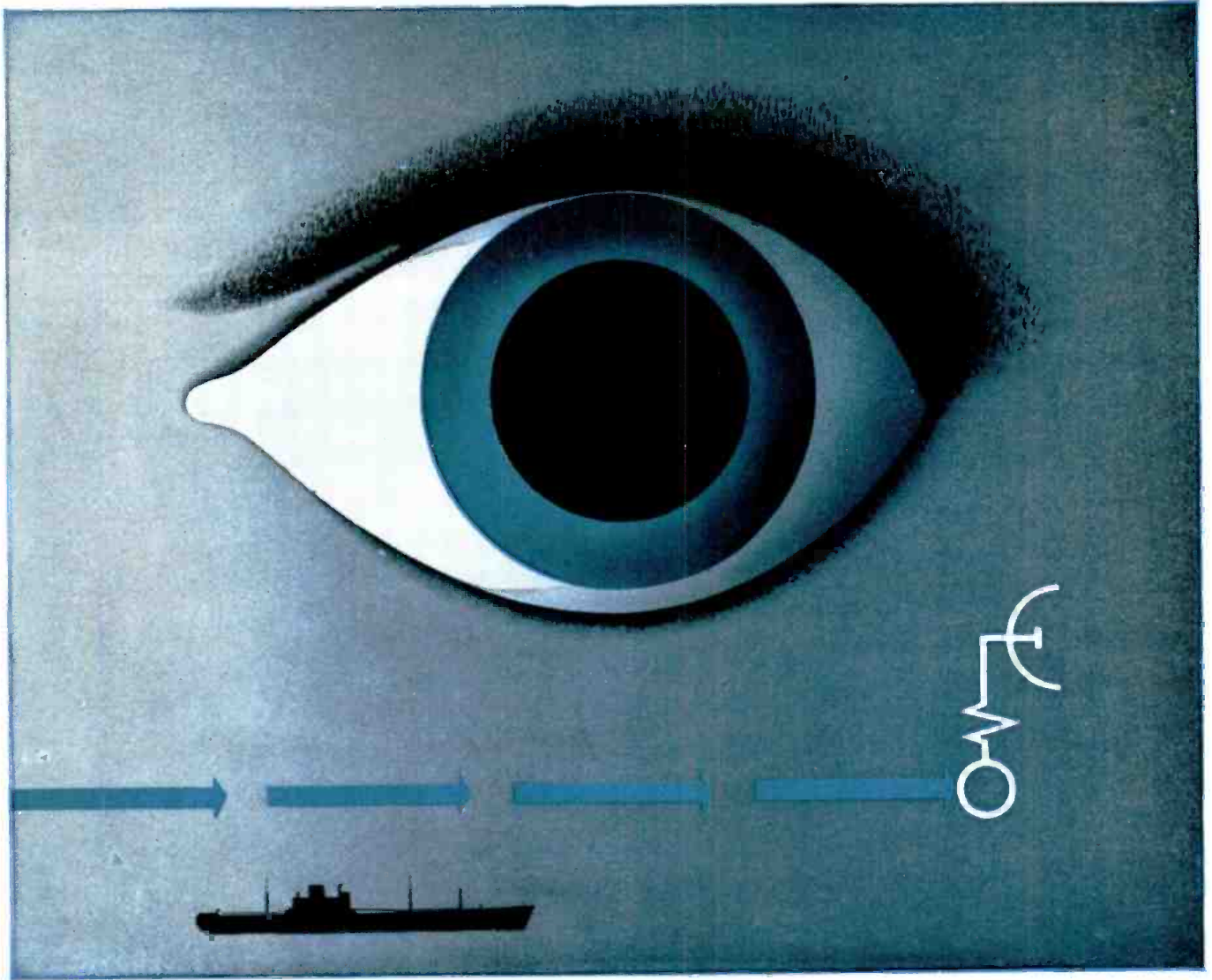

Look ahead ^{to} / _{with} Radar by Sperry

• This year, Sperry Gyroscope Company introduces its new Radar equipment for marine use.

Sperry Radar has been conceived to function better in this fundamental service: *To enable ships to operate on schedule regardless of visibility...through thick fog, heavy rain, dense smoke, darkness.*

As an aid to navigation it picks up channel markers and buoys; assists in making landfalls with assurance; spots icebergs, floating derelicts and other hazards projecting above surface. It also permits vessels to enter harbors and proceed with

all due safety and caution through fog. Another important feature: Sperry Radar provides a Gyro-Compass-controlled image and can be operated by bridge personnel without extensive technical background.

In design and construction, Sperry Radar reflects this company's many years of experience in precision manufacture of marine equipment—as well as its outstanding achievements in the field of electronics. In simplicity and dependability, this new Radar exemplifies again Sperry's ability to build superior products for merchant ship service.

Sperry Radar Features:

- Designed to meet all Class A specifications of the U. S. Coast Guard.
- Maximum range 30 miles—minimum, 100 yards.
- 10-inch picture on a 12-inch screen.
- Images presented in true or relative relationship at option of operator.
- Gives accurate ranges read from indicator instead of estimated from scope.
- Backed by world-wide service.

SPERRY GYROSCOPE COMPANY, INC. GREAT NECK, N. Y.



Division of the Sperry Corporation

★
LOS ANGELES • SAN FRANCISCO • SEATTLE • NEW ORLEANS
CLEVELAND • BROOKLYN • HONOLULU

GYROSCOPICS • ELECTRONICS • RADAR • AUTOMATIC COMPUTATION • SERVO-MECHANISMS

SYLVANIA NEWS

RADIO SERVICE EDITION

APRIL Published by SYLVANIA ELECTRIC PRODUCTS INC., Emporium, Pa.

1946

SYLVANIA SERVICEMAN SERVICE

by
FRANK FAX



NEWS OF VALUABLE TECHNICAL AIDS FOR SERVICEMEN

Because of the many ways that Sylvania Electric is able to—and does—help the radio serviceman, you will find that handling Sylvania tubes means *extra* profits for you.

For instance, there is a long list of business and technical aids, compiled specially for you by experts in their fields. Included in this valuable material are two of the latest Sylvania technical helps, the SYLVANIA RADIO TUBES CHARACTERISTICS booklet and the SYLVANIA BASE CHART.

Make sure you have these up-to-the-minute aids to better servicing. They will give you accurate characteristics and base diagrams for all the Sylvania Electric radio receiving tubes. Give your customers the most satisfactory service. Feature the famous Sylvania line of radio tubes. That deal is the best deal for you.

Obtain your copies of the aids shown at the right from your Sylvania distributor, or write directly to me at Sylvania Electric, Emporium, Pa.

LATEST REVISED TUBE
CHARACTERISTICS BOOKLET

SYLVANIA RADIO TUBES Characteristics

SYLVANIA BASE CHART

Now! get these valuable technical aids -

HANDY "PIN-UP" SYLVANIA BASE CHART

SYLVANIA ELECTRIC

Emporium, Pa.

MAKERS OF RADIO TUBES; CATHODE RAY TUBES; ELECTRONIC DEVICES; FLUORESCENT LAMPS, FIXTURES, WIRING DEVICES; ELECTRIC LIGHT BULBS

I'LL SHOW YOU HOW TO SUCCEED IN RADIO

Here's the right training for Big Post-War Pay!



F. L. Sprayberry, one of the country's foremost Radio Teachers.



A RADIO SERVICE BUSINESS OF YOUR OWN



A GOOD JOB IN RADIO & TELEVISION BROADCASTING



RADIO-ELECTRONIC SERVICE ENGINEER

BE A RADIO-ELECTRONICIAN



I SUPPLY A FULL RADIO SET for practical easy LEARNING

NOW! YOU CAN PREPARE AT HOME IN YOUR SPARE TIME FOR THE AMAZING OPPORTUNITIES AHEAD IN RADIO — ELECTRONICS — TELEVISION

The offer I make you here is the opportunity of a lifetime. It's your big chance to get ready for a wonderful future in the swiftly expanding field of Radio-Electronics INCLUDING Radio, Television, Frequency Modulation and Industrial Electronics. Be wise! NOW's the time to start. Opportunities ahead are tremendous! No previous experience is necessary. The Sprayberry Course starts right at the beginning of Radio. You can't get lost. It gets the various subjects across in such a clear, simple way that you understand and remember. And, you can master my entire course

in your spare time. It will not interfere in any way with your present duties. Along with your Training, you will receive my famous BUSINESS BUILDERS which will show you how to make some nice profits while learning.

Prepares You for a Business of Your Own or Good Radio Job

My training will give you the broad, fundamental principles so necessary as a background, no matter which branch of Radio you wish to specialize in. I make it easy for you to learn Radio Set Repair and Installation Work. I teach you how to install and repair Electronic Equipment. In fact, you'll be a fully qualified RADIO-ELECTRONICIAN, equipped with the skill and knowledge to perform efficiently and to make a wonderful success of yourself.

Just Out! FREE!

"How to Read Radio Diagrams & Symbols" a valuable new book which explains in simple English how to read and understand any Radio Set Diagram. Provides the quick key to analyzing any Radio circuit. Includes translations of all Radio symbols. Send for this FREE book now, and along with it I will send you another big FREE book describing my Radio-Electronic training.



GET FREE BOOKS

SPRAYBERRY TRAINING GIVES YOU BOTH TECHNICAL KNOWLEDGE SKILLED HANDS

There's only one right way to learn Radio Electronics. You must get it through simplified lesson study combined with actual "shop" practice under the personal guidance of a qualified Radio Teacher. It's exactly this way that Sprayberry trains you... supplying real Radio parts for learn-by-doing experience right at home. Thus, you learn faster, your understanding is clear-cut, you acquire the practical "know how" essential to a good-paying Radio job or a Radio business of your own.

I'll Show You a New, Fast Way to Test Radio Sets Without Mfg. Equipment

The very same Radio Parts I supply with your Course for gaining pre-experience in Radio Repair work may be adapted through an exclusive Sprayberry wiring procedure to serve for complete, fast, accurate Radio Receiver troubleshooting. Thus, under Sprayberry meth-

ods, you do not have one cent of outlay for manufactured Test Equipment which is not only expensive but scarce.

Read What Graduate Says "One Job Nets About \$26.00"

"Since last week I fixed 7 radios, all good-paying jobs and right now I am working on an amplifier system. This job alone will net me about \$26.00. As long as my work keeps coming in this way, I have only one word to say and that is, 'Thanks to my Sprayberry training' and I am not afraid to boast about it." — ADRIEN BENJAMIN, North Grosvenordale, Conn.

DON'T PUT IT OFF!

Get the facts about my training—now! Take the first important step toward the money-making future of your dreams. All features are fully explained in my big, illustrated FREE Catalog which comes to you along with another valuable FREE book you'll be glad to own. Mail Coupon AT ONCE!

RADIO CRAFT

AND POPULAR ELECTRONICS

Incorporating
SHORT WAVE CRAFT TELEVISION NEWS
RADIO & TELEVISION



HUGO GERNSBACK, *Editor-in-Chief*
FRED SHUNAMAN, *Managing Editor*
MAJ. M. H. GERNSBACK, *Cons'l't'g Ed.*
I. QUEEN, *Editorial Associate*
ELMER FULLER, *Shortwave Editor*
A. PASCALE, *Production Manager*
G. ALIQUO, *Circulation Manager*
JOHN J. LAMSON, *Advertising Director*
ALFRED STERN, *Promotion Manager*

IN THE NEXT ISSUE

Hi-Fi Tuner P.A. Amplifier
FM Carrier Stabilization
Clamping Circuits
Hum Level Reduction

Published by Radcraft Publications, Inc.
Publication Office: 29 Worthington Street, Springfield 3, Mass.
Editorial and Advertising Offices: 25 West Broadway, Tel. RE 2-9690, New York 7, N. Y.
Chicago Advertising Office: Radio-Craft, 308 W. Washington Street, Suite 1413, Chicago 6, Ill. Tel. Randolph 7363.
Cleveland Advertising Office: 405 Erie Bldg., Cleveland, Ohio. Burdette Phillips, Manager. Tel. Main 9645.
Los Angeles Advertising Office: 606 South Hill Street, Los Angeles 14, Calif. Ralph W. Harker, Manager.
San Francisco Advertising Office: 582 Market St., San Francisco 4, Calif. Ralph W. Harker, Manager. Tel. Garfield 2481.
RADIO-CRAFT is published monthly on the 25th of the month preceding that of date. Subscription rates: United States and possessions, Mexico, Central and South American countries, \$2.50 a year, \$4.00 for two years, \$6.00 for three years. Canada, \$3.00 a year, \$5.00 for two years, \$7.50 for three years. All other foreign countries, \$3.25 a year, \$5.50 for two years, \$8.25 for three years. Special rates for members of the Armed Forces in U. S., or those addressed by A.P.O. or F.P.O. mail, \$2.00. Entered at the post office at Springfield as second-class matter under the Act of March 3, 1879. All communications about subscriptions should be addressed to: Circulation Manager, Radio-Craft, 29 Worthington St., Springfield 3, Mass.

Notice of CHANGE of ADDRESS should reach us at least one month in advance. When ordering a change, please furnish an address stencil impression from a recent wrapper if you can. Address changes cannot be made without the old address as well as the new.

Foreign Agents

London—Atlas Publishing and Distributing Co., Ltd., 18 Bride Lane, Fleet St., London, E.C. 4.

Melbourne—McGill's Agency, 179 Elizabeth St., Australia.

Text and illustrations of this magazine are copyright and must not be reproduced without permission of the copyright owners. Copyright, 1946, Radcraft Publications, Inc.

RADCRAFT PUBLICATIONS, INC.:
Hugo Gernsback, *President*
Maj. M. Harvey Gernsback, *Vice Pres.*
G. Aliquo, *Secretary*

Contents

April, 1946

Volume XVIII No. 7

Editorial: The Growth of Radio	by Hugo Gernsback	457
Radio-Electronics Monthly Review		458
Moon-Radio Predicted in 1927		502
Radio Thirty-Five Years Ago		516

ELECTRONICS

Now—A Radio Pen	by Mohammed Ulysses Fips, I.I.R.R.E.E.	462
Radio to the Moon	by Lieut. Col. John H. DeWitt	464
Five New Circuits	by Roy M. Cater	467
Landings by Radar	by Leonard David Callahan	468
Waves and Pulses	by Jordan McQuay	470
The Crystal Filter, Part II	by Robert W. Ehrlich	476

SERVICING

The Oscilloscope	by S. D. Prenskey	460
Signal Tracing Methods		472
Data Sheet No. 334 (Farnsworth Models ET-064, ET-065, ET-066)		475

CONSTRUCTION

32-Volt Receiver	by Lyle Treakle	466
Vertical Rhombics	by T. J. White	469

SOUND

Vibrator Amplifier	by John S. Straede	473
A Novel Amplifier	by J. C. Hoadley	474

TEST INSTRUMENTS

A Trouble Chaser	by Homer L. Davidson	465
------------------	----------------------	-----

DEPARTMENTS

World-Wide Station List	Edited by Elmer R. Fuller	478
Radio-Electronic Circuits		480
Try This One		486
The Question Box		488
New Radio Patents	by I. Queen	500
Why Not?		507
Communications		512
Book Reviews		515

Biographical portrait drawings by Constance Joan Naar



ON THE COVER

The cover this month shows Lieutenant Colonel John DeWitt of the Signal Corps and a part of the apparatus with which he contacted the moon. Other pictures appear in the story on page 464.

Chromatone by Alex Schomburg from PM photo

hallicrafters *new Model* S-40

New beauty and perfect ventilation in the perforated steel top

Separate electrical bandspread with inertia flywheel tuning.

Tuning range from 540 kc to 42 Mc continuous in four bands

Self-contained, shock mounted, permanent magnet dynamic speaker

All controls logically grouped for easiest operation. Normal position for broadcast reception marked in red, making possible general use by whole family.

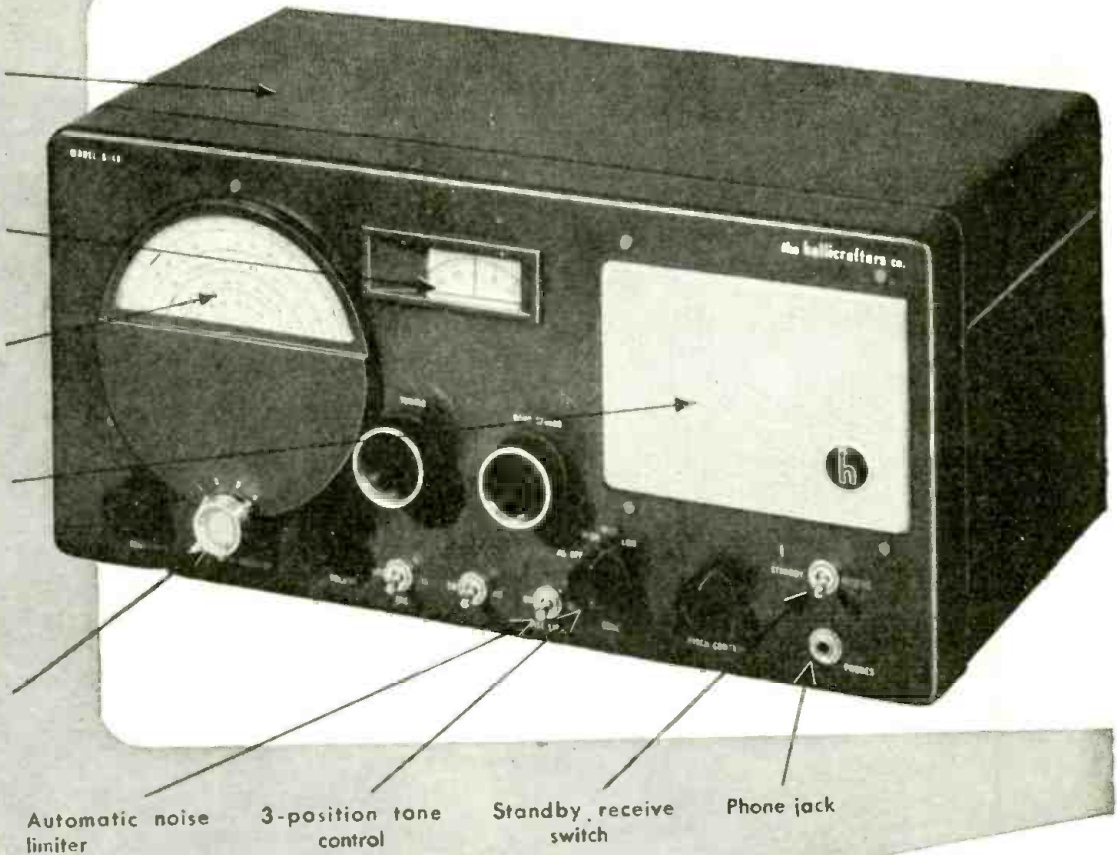

Automatic noise limiter

3-position tone control

Standby, receive switch

Phone jack

New design, new utility in a great (APPROXIMATELY) **\$79⁵⁰**
new communications receiver . . .

Here is Hallicrafters new Model S-40. With this great communications receiver, handsomely designed, expertly engineered, Hallicrafters points the way to exciting new developments in amateur radio. Read those specifications . . . it's tailor-made for hams. Look at the sheer beauty of the S-40 . . . nothing like it to be seen in the communications field. Listen to the amazing performance . . . excels anything in its price class. See your local distributor about when you can get an S-40.

INSIDE STUFF: Beneath the sleek exterior of the S-40 is a beautifully engineered chassis. One stage of tuned radio frequency amplification, the S-40 uses a type 6SA7 tube as converter mixer for best signal to noise ratio. RF coils are of the permeability adjusted "micro-set" type identical with those used in the most expensive Hallicrafters receivers. The high frequency oscillator is temperature compensated for maximum stability.

From every angle the S-40 is an ideal receiver for all high frequency applications.

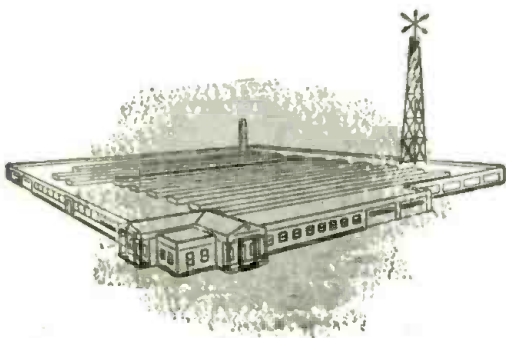

©COPYRIGHT 1945 THE HALLICRAFTERS CO.

hallicrafters RADIO

THE HALLICRAFTERS CO., MANUFACTURERS OF RADIO AND ELECTRONIC EQUIPMENT, CHICAGO 16, U. S. A.

Sole Hallicrafters Representatives in Canada: Rogers Majestic Limited, Toronto - Montreal



The sign of Quality



Centralab RADIOHMS

For ALL Replacement Jobs

For more than two decades servicemen have recognized the "CRL" in the Centralab diamond as a symbol of Quality . . . and so today as in those early pioneer times . . . wise servicemen "always specify Centralab".

Centralab

Division of GLOBE-UNION INC., Milwaukee

PRODUCERS OF



Variable Resistors
Bulletin 697



Selector Switches
Bulletin 722

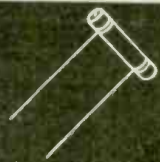

Tubular Ceramic
Capacitors
Bulletins 630 and 586

SOON WE'LL PHONE HOME FROM AUTO
 RADIO INDUSTRY POISED FOR BIG BOOM
 Big Boom in FM Broadcasting
 Seen
 MARKET FOR 100 MILLION RADIOS REVEALED BY SYLVANIA SURVEY
 OVER FIVE- OR SIX-YEAR PERIOD, RESEARCHERS FIND
 COAST TO COAST NETWORK BEING PLANNED FOR FM

Let TODAY'S HEADLINES Guide You to TOMORROW'S OPPORTUNITIES

Learn RADIO ELECTRONICS DeFOREST'S MODERN "A-B-C" WAY .. at Home



Plan your future the way business men do: Watch the headlines! Pick a field that's "in the news"—one with many opportunities for interesting, PROFITABLE EMPLOYMENT or a good chance for establishing a BUSINESS OF YOUR OWN with little capital. Pick a field that offers a variety of interesting opportunities—a field with one of America's most promising futures... and see how you may MAKE YOUR START TOWARD A PLACE IN THIS FIELD BEFORE JOB COMPETITION BECOMES ACUTE. Write for DeForest's Big, Free, Illustrated Book—"VICTORY FOR YOU." Learn how DeForest's prepares you at home, in your leisure time—without interfering with the work you are now doing—then helps you make your start in the vast BILLION DOLLAR Radio-Electronics field.

You Get EMPLOYMENT SERVICE

DeForest's Employment Service offers you the advantage of long and favorable contacts with some of America's foremost Radio-Electronics concerns. "VICTORY FOR YOU" tells you how this Service has helped many to their start in Radio-Electronics. You'll see how DeForest students and graduates are prepared to win and to hold good paying jobs—how DeForest students start businesses of their own with little, if any, capital.

A You "LEARN-BY-DOING" at Home with Practical Equipment

Enjoy a "Home Laboratory." DeForest's provides 8 BIG KITS OF RADIO ASSEMBLIES AND PARTS to give you valuable practical experience at home. Build modern Radio Receivers and Circuits that operate. Build Electric Eye Devices, an Aviation Band Receiver, a Public Address System, a Wireless Microphone and numerous other fascinating experiments—in fact, 133 in all, in your spare time at home. NEW colorful Kit Supplement tells you about DeForest's "Home Laboratory," and how you use valuable Radio parts and sub-assemblies to get real practical experience as you learn.

DeForest's Training includes instruction in Motion Picture Sound Equipment, FM Radio and Television.

C WELL-ILLUSTRATED LOOSE-LEAF LESSONS

DeForest's provides 90 loose-leaf lessons prepared under the supervision of the man often referred to as the "Father of Radio"—Dr. Lee DeForest, inventor of the Audion Tube, and holder of over 300 important patents. . . . ACT PROMPTLY! See how you can learn Radio the

modern A-B-C DeForest's way—by Reading . . . by Doing . . . by Seeing at Home. Mail coupon Now!

B Home MOVIES Help You Learn FASTER...EASIER

With DeForest's, you use a genuine DeVRY 16 mm. Motion Picture Projector and exciting training films to help you learn some of Radio's fundamentals FASTER . . . EASIER. SEE what happens inside of many circuits you are working on. SEE how electrons function. SEE how RADIO waves are changed into sound. Get DeForest's big, free book! Use it as a key to show you the way to Radio-Electronics job opportunities of today and tomorrow—the opportunities the headlines tell about.

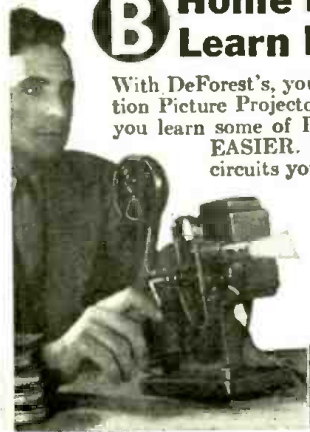

SEND FOR FREE BOOK & SUPPLEMENT TODAY!

DeFOREST'S TRAINING INC., Chicago, Ill.

DeFOREST'S TRAINING, INC.,
 2533-41 N. Ashland Ave., Dept. RC-C4
 Chicago 14, Illinois, U. S. A.
 Send me both your big book "VICTORY FOR YOU" and Kit Supplement, showing how I may make my start in Radio-Electronics with your modern A-B-C home training plan. No obligation.



Name _____ Age _____
 Address _____ Apt. _____
 City _____ Zone _____ State _____
 If under 16, check here for special information. If a discharged veteran of World War II, check here.



Get Ready for POSTWAR RADIO ELECTRONICS AND TELEVISION NOW!

Great strides of progress have been made during the war. New equipment, methods, uses have been developed. Keep in the lead yourself with modern

SHOP METHOD HOME TRAINING BY A GREAT ESTABLISHED RESIDENT SCHOOL



NATIONAL SCHOOLS HAS BEEN BRINGING OPPORTUNITY TO AMBITIOUS MEN FOR MORE THAN A THIRD OF A CENTURY. Above and to the right are two departments in this great school where modern developments are analyzed to provide National students with first-hand knowledge of short cuts and trade secrets. For full details fill out the coupon.



Take your place in the forefront of Radio, Television and Electronic progress. Get your share of the NEW business. War inventions and improvements—walkie-talkies, radar, aircraft control and communications—will quickly be adapted to civilian use. F.M. is winning almost universal acceptance and use.

Everywhere you turn new and important changes in the field of Radio are being put into operation every day. Television is rapidly being perfected. Electronics is being applied to industry and better living. The successful technician **MUST KEEP UP WITH PROGRESS** if he is going to be sure of his job—**GET AHEAD IN BUSINESS.**

National Schools presents a Radio and Electronic training system geared to the rapid advancement of the industry itself. Here is an exclusive home training system based on the shop methods as practiced in one of the World's foremost vocational education centers—the actual shops and experimental laboratories of this National institution. Send the coupon on the next page for complete details. Only National can bring you this type of training for only National has the shops, equipment and experimental laboratories for the development and extension of the system.

Use This Modern Electronic Laboratory



The very essence of National Shop Method Home Training is **EXPERIENCE**. You get to know Radio and Television circuits by building them yourself. You get

first-hand knowledge of how instruments work by a sound analysis and construction system.

You build a beautifully toned, high fidelity, long distance modern super-

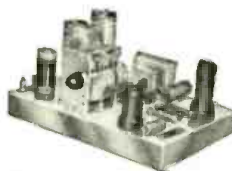
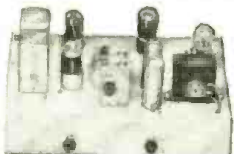

heterodyne receiver from the parts furnished with your course. In this way you have a thorough understanding of the superheterodyne principle. You learn modulation,

beat frequency and signal generation by building yourself a small, operating radio transmitter with National parts. You get to know and

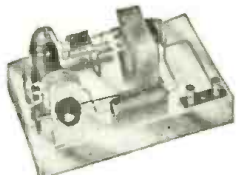

understand the process of creating audible signals by electronic means by conducting experiments with a National Audio Oscillator.

You conduct cathode ray experiments to gain a first-hand knowledge of the operation, repair and maintenance of Television equipment. Hundreds of experiments may be performed to gain first hand experience with your National laboratory equipment.



New Fields

Electronics is already a most important factor in industry. Many manufacturing processes depend on electronic controls—employ electronic processes. In medicine and agriculture, too, electronics is being used extensively. Are you ready to cash in on this development in a field that is so close to radio?



New Equipment

Every day you learn of new types of radios and improved television—new electronic devices. Fac-simile, F.M., Radar, Sonar—all present new problems of manufacture, operation and maintenance that demand training and experience. Consider your advantages if you have the necessary preparation to tackle this work.



New Hook-Ups

The relatively simple wiring of the radio receiver of a few years ago is as out-of-date today as one of the first automobiles. The new Radio and Television sets, and Electronic devices demand a thorough knowledge of new principles. National brings its students the results of continuous research and improved methods.

NEW OPPORTUNITIES

FREE LESSON

Think what all this great progress in Radio, Electronic power and control and Television means to YOU PERSONALLY—you who are already in Radio or have a natural inclination toward it. The greatest opportunity of a lifetime is right within your grasp.

The man trained in modern Electronics CAN CHOOSE THE KIND OF INDUSTRY HE WANTS—THE PART OF THE COUNTRY HE PREFERS AND THE KIND OF POSITION MOST SUITABLE.

YOU WANT ACTION

With this amazing speed-up training you can progress just as quickly as you wish—start taking advantage of your new found knowledge and experience in a very short time. Send the coupon below and learn the facts about this great educational development. Try out the FREE SAMPLE LESSON and see for yourself what you can accomplish so quickly and easily with the remarkable SHOP METHOD HOME TRAINING.

Compare the job you now have or expect to get when you are out of service or your present war job with the great future presented you by the broad field of Electronics.

Literally tens-of-thousands of technicians are needed in Radio and Television stations and communications companies all over the country—to operate, maintain and repair equipment. The man who knows modern methods and equipment is welcome almost at his own price.

Latest figures show that Radio represents a 5-billion dollar industry and, in the opinion of experts, it is a secure, well-established, basic type of business offering steady employment. Television, according to authorities, offers half a million openings right at the start.

In a few months—perhaps only weeks—you may start making good money; maybe accept a BIG PAY JOB in industry—GET INTO A PROFITABLE, LIFETIME BUSINESS OF YOUR OWN, with little or no capital investment.

Take the first step now. Fill out and mail the coupon below.

Get this BOOK

Here is an interesting forecast of the future of Radio and the opportunities present for you in this, and allied fields right now. It is profusely illustrated and describes the jobs waiting for trained men everywhere. Send the coupon below for your copy.



Here Are Some Samples of Success in Radio by National Graduates

National Shop Method Home Training wins good jobs, independence and security quickly. Take the word of National men who have established records in their favorite Radio, Television, or other branches of Electronics:



From O. K. Ivey, Washington, D. C., comes this endorsement: "I believe National offers the best course to be had. Keep up the good work."



Joseph Grumlich, Lake Hiawatha, New Jersey writes: "My latest offer was \$5,800.00 as Radio Photo Engineer but I'm doing well where I am now engaged. I am deeply indebted to National."



Robert Adamsen, Kearney, Nebraska, National graduate, has two radio jobs—makes double pay as a radio instructor and as engineer at Station KGFV. He writes: "I am proud of My National training and appreciate the co-operative spirit."



Here's a statement from R. R. Wright, Blackfoot, Idaho: "Due to my training at National I was selected to instruct in the laboratory work of Navy and Marines."

Read what hundreds of other enthusiastic students have written about National Training. Send in your coupon today.

NATIONAL SCHOOLS

LOS ANGELES 37, CALIFORNIA EST. 1905

MAIL OPPORTUNITY COUPON FOR QUICK ACTION

National Schools, Dept. RC-4
4000 South Figueroa Street, Los Angeles 37, California

(Mail in envelope or paste on penny post card)

Mail me FREE the two books mentioned in your ad including a sample lesson of your course. I understand no salesman will call on me.

NAME AGE

ADDRESS

CITY STATE

Include your zone number

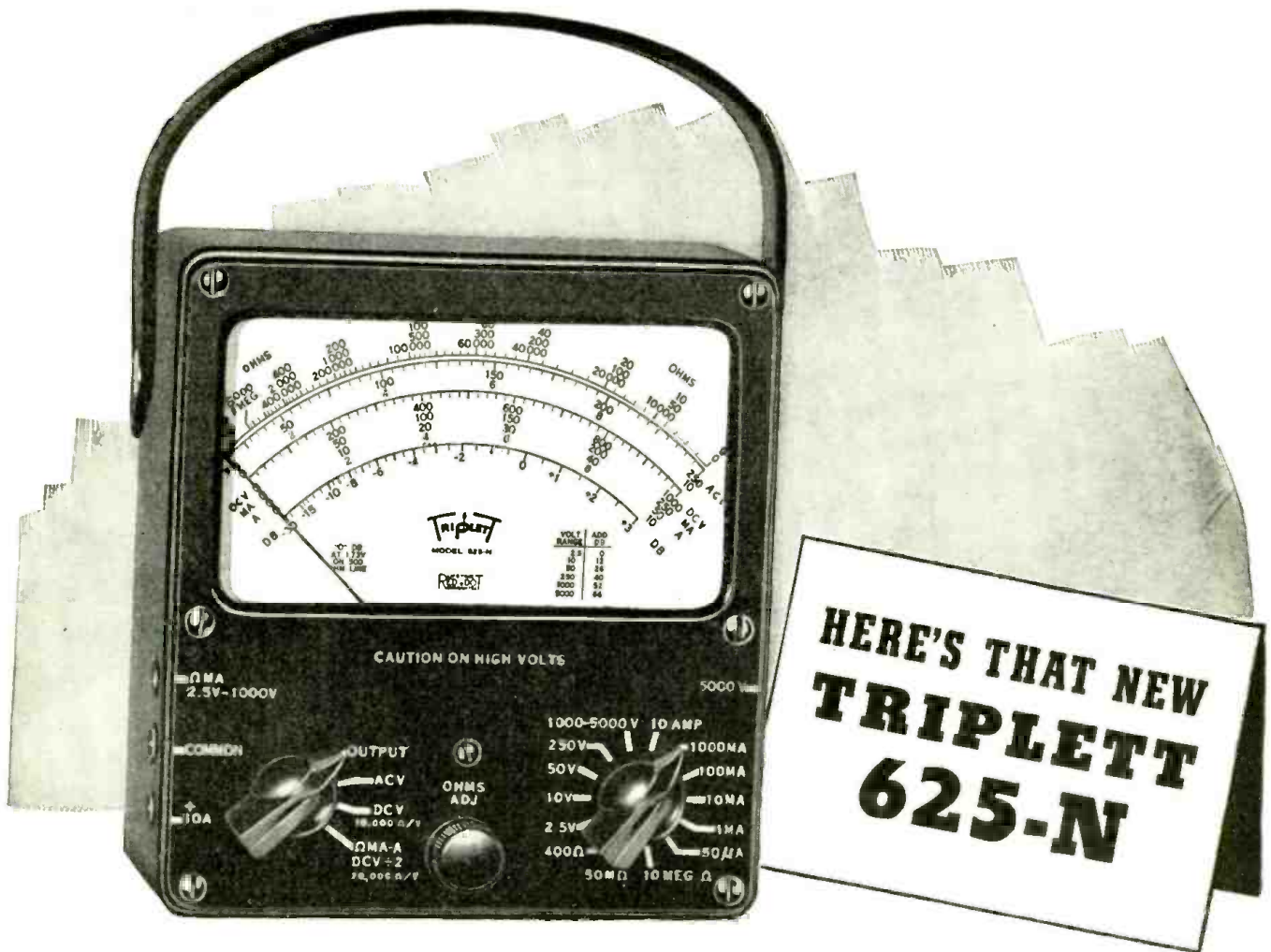

LONG SCALE, WIDE RANGE VOLT-OHM-MILLIAMMETER

DOUBLE SENSITIVITY D. C. VOLT RANGES

0-1.25-5-25-125-500-2500 Volts,
at 20,000 ohms per volt for greater accuracy on
Television and other high resistance D.C. circuits.

0-2.5-10-50-250-1000-5000 Volts,
at 10,000 ohms per volt.

A. C. VOLT RANGES

0-2.5-10-50-250-1000-5000 Volts,
at 10,000 ohms per volt.

OHM-MEGOHMS

0-400 ohms (60 ohms center scale)
0-50,000 ohms (300 ohms center scale)
0-10 megohms (60,000 ohms center scale)

DIRECT READING OUTPUT LEVEL DECIBEL RANGES

-20 to +3, +15, +29, +43, +55, +69 DB

TEMPERATURE COMPENSATED CIRCUIT FOR
ALL CURRENT RANGES D.C. MICROAMPERES
0-50 Microamperes, at 250 M.V.

D. C. MILLIAMPERES

0-1-10-100-1000 Milliampères, at 250 M.V.

D. C. AMPERES

0-10 Amperes, at 250 M.V.

OUTPUT READINGS

Condenser in series with A.C. Volts for output
readings.

ATTRACTIVE COMPACT CASE

Size: 2½" x 5½" x 6". A readily portable, completely
insulated, black, molded case, with strap handle.
A suitable black, leather carrying case (No. 629)
also available, with strap handle.

LONG 5" SCALE ARC

For greater reading accuracy on the Triplet
RED • DOT Lifetime Guaranteed meter.

SIMPLIFIED SWITCHING CIRCUIT

Greater ease in changing ranges.

Write for descriptive folder giving full technical details



Triplet



ELECTRICAL INSTRUMENT CO. BLUFFTON, OHIO

RADIO-CRAFT for APRIL, 1946

THE GROWTH OF RADIO

Radio-Electronics Is Now in Its Full Stride of Expansion

THE bewildering growth of radio-electronics—already great before the war—has now assumed such astonishing proportions that it leaves even complacent radio engineers quite breathless these days. The art is branching out so rapidly as to assume the proportions of an avalanche, growing from day to day as its momentum gathers speed.

It may be doubted if there is any radio-electronic engineer alive today who can truthfully say that he knows intimately *all* the various ramifications of radio now extant.

The art has become so huge, particularly since the war, that it is impossible even for professional radio men to keep track of all its complexities. Radio literature, large as it is today, finds it difficult to report all progress achieved in the art and in the industry. Often only the barest outline of some new development is reported.

New inventions, new applications, new patents, new processes come along in such an abundance and with such speed that it is difficult even for experts to cope with the huge output. Literally nothing astonishes either engineer or layman when new claims and new applications are made in radio-electronics nowadays. Even a listing of all the brand new radio and electronic applications which have been developed since V-J Day, would fill far more space than does this article.

Every branch of radio-electronics is becoming so complex that only specialists in their respective spheres can begin to cope with the new facts, new inventions, new procedures, in that particular branch. As an example take a single component: Vacuum Tubes. Tubes of the size of 600 kw and over, down to the new miniature tubes, the size of a small bean, are now commonplace. In between there are literally thousands of styles and models of radio tubes for a variety of purposes. The listing of each alone would also fill a good-sized volume.

Whether these tubes are of the ordinary receiving type, whether they are klystrons, magnetrons, cathode-ray, or the 40-foot type used in atomic research, they are all radio-electronic vacuum tubes, built for a specific purpose. The highly technical engineering knowledge necessary in designing and manufacturing these tubes is a vast specialized endeavor in itself.

The same is true of every other sub-division of radio-electronics. It happens ever so often that when an engineer talks to one in another radio-electronic branch they discover that each has only the most

superficial knowledge of what the other is talking about. Frequently engineers of two different branches must study intensively to work in cooperation with each other.

It has frequently happened that one radio sub-division has duplicated efforts which already were standard in another, simply because there had not been sufficient literature in the two branches to read up on. This should give some sort of an idea how really big radio-electronics is becoming and what is in store for us during the coming years.

Even engineering libraries today are hard put to keep up with the heavy traffic in recording, indexing and cross-indexing all the new research and developments in the art. Particularly since the war, with its security secrecy, a terrific load has suddenly been placed on the entire radio engineering fraternity even to begin digesting a fraction of what has been accomplished in the art during the war years. The pace simply has been too great and it will take many months of patient plodding for all in the industry to get a correct perspective of the present radio picture.

That is not all, by any means. Atomics, which will soon rival radio-electronics, is already making use of many radio, electronic and allied devices. Soon radio engineers will be in greater and greater demand in the atomic field.

Take the Cyclotron, the Betatron and other instrumentalities in the same class—they all require radio-electric components, with devices such as amplifiers, special vacuum tubes, cathode-ray tubes, in a profusion of complicated hook-ups. For the detecting and measuring of radioactivity, atomic scientists require Geiger-Mueller vacuum tubes, photo-electric multiplier cells, ionization chambers (with argon gas), etc. All three of these in turn require special direct current amplifiers, audio oscillators, radioactivity indicators and many other radio-electronic components.

Remember, too, that the young atomic giant is still in its merest infancy. It is a foregone conclusion that atomics and radio-electronics will soon be allied inextricably, to an extent undreamt of at present.

Radio-electronics, with the possible exception of atomics, will probably become the greatest endeavor that humanity has ever seen. One thing is quite certain. That is, the extent and scope of the rapidly growing art will be far greater than any other art ever known on earth heretofore.

RADIO-ELECTRONICS

Items Interesting

COLOR TELEVISION RECEIVERS

instead of the black-and-white variety will be manufactured by Zenith, stated Commander E. F. MacDonald, last month. The strong statement by the head of Zenith is especially interesting, coming as it does in the middle of a more-than-warm debate between CBS and RCA over the possibility of color television in the early future. RCA insists that color will not be ready for the public in the next five years, and has said so in no uncertain terms. Columbia, on the other hand, believes that it may be feasible within the current year.

Mr. MacDonald, who witnessed a CBS ultra-high frequency demonstration recently, declared that it is "unfair" to sell any television receivers to the public in the 50 megacycle band—the black-and-white band—which, he said, even the Federal Communications Commission concedes is a temporary assignment.

It would be difficult, according to the Zenith president, to estimate the additional cost of a color set as against black and white, but that the 15 percent quoted by CBS would be a "fair approximate" figure. He remarked that the public could enjoy color without additional cost after the original purchase of a receiver.

PRINTED RADIO CIRCUITS

made with conductive inks on ceramic sheets may make it possible to cut down the size of portable radios far beyond present concepts of postwar portables, it was revealed last month by Dr. Cleo Brunetti, of Transitron fame.

Tiny radio receivers giving reception equal to that now provided by table model sets would be possible. The receivers would be no larger than a cigarette package. Tubes for the circuit have been developed and a special loudspeaker designed. Miniature battery or house current could supply power.

The circuit is printed on a ceramic plate, avoiding all the complicated wir-

ing usually found in radio equipment. It was first used for the proximity fuse, which was a miniature radio set causing a shell to explode when it approached a target.

Dr. Brunetti, who is now with the Bureau of Standards, explained the printing process to a meeting of radio engineers at Marquette University:

"On a ceramic plate is laid a silk mask with a pattern cut in it. Over this mask is drawn a plastic bar, like the rollers of a printing press, with a thick paste of dissolved silver. The impression left on the plate is like the wiring of the circuit, only instead of copper wires we have silver lines.

"Next another mask is placed over the plate and sprayed with a carbon solution. When the mask is removed there are all of the resistors assembled in a circuit. Thin condensers are attached to the circuit and the wiring is completed."

NAVAR has added its name to the various proposed plane landing and ground-controlled approach (GCA) systems for planes, according to a last month's *Science Service* report. A radar-type system, it offers some advantages over other types of landing control, according to Henry Busignies of International Telephone and Telegraph Corporation, producers of the apparatus.

The Navar system, he stated, would project an electronic "moving picture" on a chart in the airport control center, showing the location and identity of every plane in the sky within 80 miles of the airport. In addition to the constantly moving radar picture in the ground-based control room, the pilot of a navar-equipped plane will see on his own radar scope his own and all other aircraft near his position and altitude, in relation to each other and to the ground, in one map-like indication.

The ground radar installation will show the planes in the area on three scopes, each scope covering a certain category of aircraft. *Member* planes are those equipped with navar and tuned to the local control station; *guests* are planes whose navar sets are tuned to another station; and *strangers* are aircraft without navar. At the ground navar station the images of all planes in all three scopes are transmitted through a specially designed projector onto a large map of the area on a wall screen.

In addition to the lateral positions of planes in the area, the figures on the map representing member planes will show adjacent groups of letters and numbers identifying each plane and telling its altitude. The equipment permitting this feature is based on the IFF (identification, friend or foe) automatic

radar method used by aircraft during the war. This IFF equipment answers automatically certain "stock" questions about flying conditions without attention of the crew.

EDDIE STARTZ, world's most famous radio announcer, is again back on the air over PCJ and PHI. In a letter to the American branch of the Philips Co. last month, he described how engineers sabotaged Nazi propaganda from the famous Eindhoven stations.

"Shortly before the Allied invasion in 1944" writes Startz, "a storm swept through the high antenna masts of PCJ's rotating beam, putting the directional mechanism on the circular rails out of order. Clever sabotage by the engineers made the mechanism irreparable, so for the remainder of the war all Nazi propaganda broadcasts from this station were actually directed to the North and South Poles, where the polar bears enjoyed excellent reception."

Before the war, Startz was known to short wave listeners throughout the world as the seven-language announcer since he spoke equally well in English, Dutch, Malay, German, French, Spanish and Portuguese. Startz discontinued announcing when the Germans arrived and became active in the Dutch underground. *Radio-Craft* received a number of inquiries from short-wave listeners about him, during this period, but neither Philips nor anyone else knew whether he had escaped the Nazis or not. He is now living in Hilversum, Holland.

RADAR STORM WARNING sets are being installed at forty airfields, Colonel Thomas S. Moorman, deputy chief of the Air Forces Weather Service, announced last month.

These small radar units will be able to picture the approach of storms and squalls, thus providing ample warning in localities where rapid weather changes are commonplace. One of the sets will be located at Mitchel Field, and all are expected to be installed in time for next spring's thunderstorm season.

It was pointed out that radar supplements but does not replace the regular weather service. Only short-range forecasts are possible with radar apparatus, the most powerful equipment being able to detect storms not more than about six hours away. The regular meteorological service is required for longer forecasts. The storm has to be within radar range of the field and contain enough rain or heavy moisture-laden clouds to reflect signals. This short-range forecasting is useful for detecting dangerous local thunderstorms.



Dr. Brunetti holds one of the little "radio chassis" while demonstrating how—with the help of sub-miniature tubes—radios can be made smaller than present-day hearing aids.

MONTHLY REVIEW

to the Technician

ELECTRONIC NAVIGATION has been adopted on the Baltimore-Norfolk night boat, *City of Richmond*, a Westinghouse release announced last month. The equipment, then undergoing preliminary tests, was to be installed on the regular 185-mile night run about March first.

The new unit—which incorporates up-to-the-minute refinements of this war-born electronics development—will provide navigational and anti-collision protection in darkness, fog and all other varieties of bad weather for from 100 yards to 32 miles, according to a joint announcement by Mr. Burnside and R. E. Dunn, president of the Baltimore Steam Packet Company, operators of the 106-year-old Old Bay Line.

The installation is of the continuous plan position indicator type. This means that it provides a continuous picture of ship traffic and shoreline conditions throughout a range of from 100 yards to 32 miles of the vessel at all times.

For hazardous close-in navigation—in narrow channels and when approaching piers or other craft—the entire seven-inch viewing area of the receiver-indicator will duplicate a circle of only four miles across, with the ship in the center, thus providing maximum detail. Less detailed observations will be made viewing a circle 16 miles in diameter, while long-range pictures will cover an area 64 miles across.

EIGHTEEN THOUSAND TUBES is the complement of an electronic calculating device whose existence was announced last month by the War Department.

Latest and mightiest of all electronic calculating machines, it is named ENIAC (Electronic Numerical Integrator and Computer). The complicated instrument is the invention of Dr. J. W. Mauchly and Mr. J. Presper Eckert, both of the Moore School, University of Pennsylvania.

The ENIAC is capable of computing 1000 times faster than the most advanced general-purpose calculating machine previously built. The electronic methods of computing used in the ENIAC make it possible to solve in hours problems which would take years on a mechanical machine—a time so long as to make such work impractical. Although originally developed to compute lengthy and complicated firing and bombing tables for vital ordnance equipment, it will solve equally complex peacetime problems.

The speed of this computer is phenomenal. The first problem put on the ENIAC, which would have required 100 man-years of trained computer's work, was completed in two weeks—of which two hours was actual electronic

computing time, and the remaining time devoted to review of the results and details of operation. If used to complete capacity, the ENIAC will carry out in five minutes more than ten million additions or subtractions of ten-figure numbers.

The machine lacks one virtue—portability. It occupies a room 30 by 50 feet and weighs 30 tons.

LORAN, long range radio navigation, is as useful in the air as aboard ship, stated Lieutenant Commander Lyle C. Read of the United States Coast Guard last month.

Tried out on a test flight, loran showed unmistakable advantages, according to Commander Read. Its greatest advantage is one that would not be apparent in surface navigation. In aviation, the time taken to compute positions is very important, as the speed of the ship is so great that by the time the position is calculated, the point may have been left many miles behind. Loran, said Read, "is the only system I know which not only can tell you where you are now, but where you will be in two minutes, instead of only 'where you were' twenty minutes ago."

A complete description of shipborne types of loran appeared in the January issue of *Radio-Craft*.

LICENSE FEES on British broadcast receivers were increased last month from 10 shillings (approximately \$2.00) per year, to one pound, or double that amount. This, British government sources say, will increase revenue from radio receiving licenses to £10,000,000.

Radio listeners and the press are not as well pleased with the increase as is the government bureau in control of radio (the Post Office) and the British Broadcasting Co. One headline asks pointedly: "How Will the BBC Spend that £1? Double Dullness or Better Radio?"

ATOM BOMB TESTS at Bikini atoll are likely to be televised, according to a joint Army-Navy statement last month. This would permit "eye-witness" studies of the explosion which would otherwise be impossible, as experts could not hope to get near enough to see anything of value and yet survive the explosion.

Under the plan being considered by the joint Army-Navy staff, television transmitters would be set up on two islands of the Bikini group.

The Army-Navy study will be submitted to Vice Admiral W. H. P. Blandy, test bomb task force commander. Television receivers would be set up on Blandy's flagship and on the press ship, both of which would be at least 20 miles from the scene of the test.



Mr. Charles Denny, Acting Chairman, FCC.

CHARLES R. DENNY has been appointed acting chairman of the Federal Communications Commission by President Truman, succeeding Paul A. Porter, who takes a higher position at the head of the Office of Price Administration.

Mr. Denny has been a member of the Commission for one year, prior to which he was its General Counsel, supervising the work of more than 60 attorneys in the Commission's law department. He first came to the attention of the public through his spirited interchanges with counsel for the House Select Committee to investigate the FCC.

Youngest member of the Commission, the 34-year-old Acting Chairman had already gained distinction in law before he joined its legal department in 1942. His previous position was chief of the appellate section in the Lands Division, Department of Justice.

FIVE THOUSAND RCA PATENTS were made available last month for listing in the *Register of Patents Available for Licensing*, a publication which was established in the Patent Office last June under direction of Secretary of Commerce Henry A. Wallace.

All patents owned by RCA are made available under terms of the corporation's standard licensing agreements as a result of this action, according to the Department.

The RCA agreements include rights under patents owned by General Electric Co., Westinghouse Electric Corp., American Telephone & Telegraph Co. and others. These rights, of course, cover only the extent to which RCA has the right to grant licenses.

The *Register* was established to aid manufacturers in finding new products for reconversion and for future years. Secretary Wallace expects many useful inventions which might otherwise remain dormant many years to be brought into early use as a result of the *Register*. The list now includes some 9,000 patents and is growing continually.

THE OSCILLOSCOPE

Every Postwar Serviceman Needs One

ALMOST everyone in radio has become familiar, in one way or another, with some use of that marvelously versatile instrument, the cathode-ray oscilloscope. So wide has been the variety of its use, that now, the oscilloscope seems to be the distinguishing badge of an electronic laboratory.

With so many possible uses of the oscilloscope, varying from simple sine-wave pictures to the highly complex forms of television and radar, the question uppermost in the mind of the one who is going to use it, is, "What particular use does the scope have for me, and how do I go about using it?" Since a list of all the possible uses would be too cumbersome to be profitable, it is the purpose of this article to divide the field into three fundamental types of scope patterns and explain selected examples from each type. Once trained to recognize the fundamental type, the user "pays his money and takes his choice," whether from the standpoint of the serviceman, instructor or technician.

The examples selected to illustrate the three fundamental types of screen patterns are listed below, each example following the fundamental type, as follows:

1—Sine-wave Form of Pattern, giving a picture of the voltage being examined, and its approximate frequency, for showing:

60-cycle supply voltage, in the form of a single cycle or a number of cycles on the screen;

Pick-up from stray fields, alternating at 60 cycles;

Audio-frequencies (other than 60 cycles), for showing: signal-generator modulating voltages; radio-receiver output voltages from the detector or audio-amplifier, with emphasis on causes of wave-distortion.

2—Phase-Difference Patterns, giving so-called *Lissajou* figures, for obtaining:

Exact frequency determinations;
Phase-relationships between input and output voltages.

3. Characteristic Curves (Voltage vs. Current), produced directly on the screen for showing:

Rectifier action, with copper-oxide crystal, or diode rectifiers;

Tube characteristics (Triode, and other type).

Before proceeding with each type of pattern in detail, it will be profitable to recall that the basic principle on which the scope operates is to produce a *spot of light*, which is electronically deflected to produce the various patterns to be shown. The construction and electronic operation of the cathode-ray tube is outlined in Figs. 1 and 2. Details of the scope circuit appeared with a thorough explanation of its action, in a previous article, "Oscilloscope for Trainees" by Keillor, in July, 1945 *Radio-Craft*. As control of this spot is of such prime importance to the further understanding of the subject, the first steps in the procedure suggested for training will be



Mr. Sol. D. Prenskey has been associated with radio training and technical writing for over 15 years. His first series of articles for "Radio-Craft" commenced October, 1937, under the title "Learn By Experimenting."

His activities include teaching at Brooklyn Polytechnic Institute, supervision of radio laboratory training at Fort Monmouth Signal Corps Civilian Training Branch, which was followed by writing technical manuals for wartime equipment and postwar television apparatus. His present position is with the Brooklyn Technical High School.

on the operating controls for *moving the spot* and then deflecting it, with a recurrent voltage, to produce a straight line.

METHOD OF PROCEDURE

NOTE: The procedure that follows is for a standard 3-inch oscillograph, such as the Dumont (model 164E), illustrated in Fig. 3, which embodies the minimum number of essential controls. Reference is also made, parenthetically, to the operation of a 5-inch scope (Dumont model 208B), shown in the photograph of Fig. 4, to illustrate the use of more flexible controls available in such highly advanced types of instrument.

1. Controlling the Spot: (a). *Focusing:* Connect the power plug to an a.c. outlet source of 117 volts at 60 cycles. Turn the instrument on by advancing the INTENSITY control clockwise. When the spot appears (after the electron tubes have had time to heat up), adjust the FOCUS control for maximum distinctness of the spot, readjusting the focus for every change made in the intensity (or brilliance) of the spot.

CAUTION: TO PREVENT DISCOLORATION OF BURNING OF THE SCREEN, DO NOT ALLOW A SMALL SPOT OF HIGH BRILLIANCY TO REMAIN STATIONARY ON THE SCREEN FOR ANY LENGTH OF TIME.

This may be avoided by decreasing

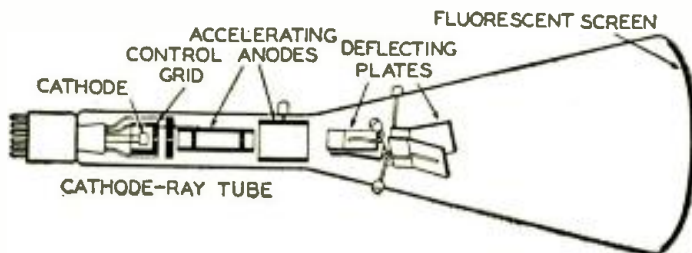

Fig. 1—Construction of electrostatic cathode-ray tube.

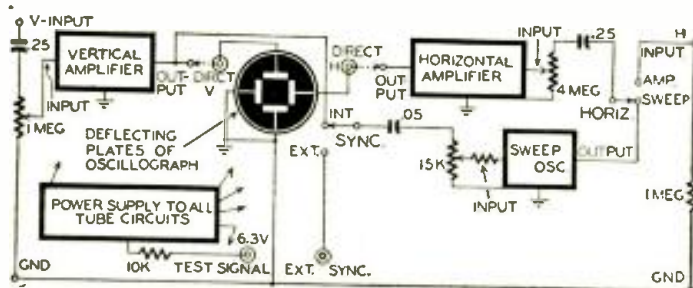

Fig. 2—Block diagram of typical cathode-ray oscilloscope.

the brilliance when working with a stationary spot, or, by spreading the spot into a horizontal line, as will be shown later.

(b). *Positioning*: Turn the V-POSITION control to move the spot up or down, and also turn the H-POSITION control to move the spot right or left. Bring the spot to the center of the screen and, leaving the other controls in their set position (which will rarely require readjustment), decrease brilliance until ready for the next step. (Note on 5-inch scope: The Dumont 208B has a separate POWER ON switch, independent of the INTENSITY control setting, and also a separate BEAM ON, which allows the filaments of all tubes to remain heated while shutting off the beam.)

2. Horizontal and Vertical Control:

(a). *Horizontal Line*: Set the V-GAIN control to zero and see that the HOR amplifier switch is in the SWEEP position. Advance the H-GAIN control to produce a horizontal deflection, about 2 inches in length. No connection need be made to the "H" input binding post, since the deflection is being produced by the amplified saw-tooth voltage obtained from the sweep-oscillator circuit of the instrument.

(b). *Vertical Line*: Return the H-GAIN control to zero. Apply a source of 60-cycle voltage to the "V" binding post and its ground terminal. (This voltage is obtained from the TEST SIGNAL binding post on the Dumont model 164E, 3-inch instrument, by means of a single wire connection from this binding post to the "V" input post.) Advance the V-GAIN control to produce a vertical deflection of about 2 inches.

3. *Producing A Sine Wave*: (a). *Single Cycle Pattern Using Sweep Controls*: Start with all controls remaining in the same position as used in the Step 2 (b) for producing the vertical line from the 60-cycle voltage. Now advance the H-GAIN control to spread the vertical line pattern to a



Fig. 3—Dumont 164E portable oscilloscope.

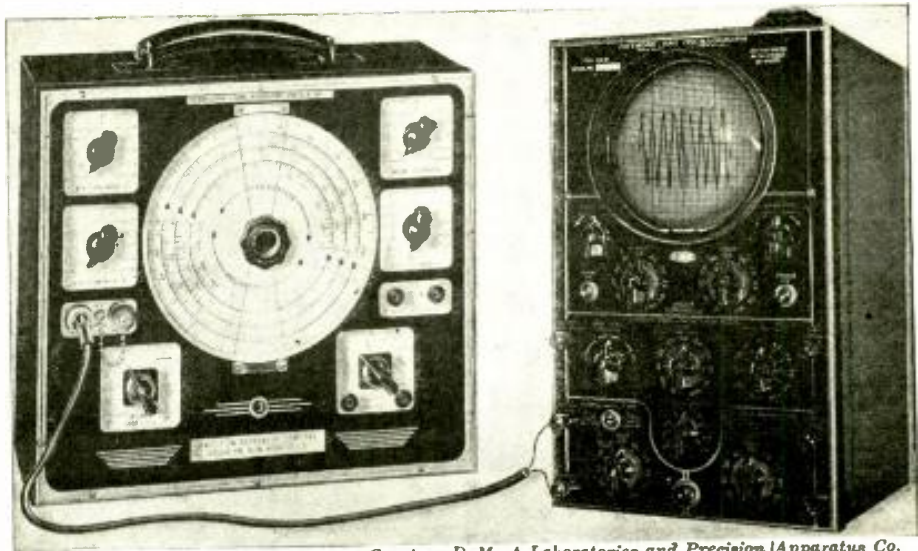

Courtesy DuMont Laboratories and Precision Apparatus Co.

Fig. 4—Wave form from signal generator as viewed on the screen of a 5-inch oscilloscope.

width of about 2 inches. The pattern obtained will depend upon the setting of two controls so far not used, namely the SWEEP RANGE and SWEEP VERNIER controls. The only other remaining control (marked SYNC) may be left untouched in a half-way advanced position. Adjust the SWEEP RANGE control to 60 (second step in its range), and then adjust the SWEEP VERNIER control until a single cycle of the sine wave appears on the screen, as illustrated in Fig. 5-a.

(b). *Use of SYNC control*: Retard the SYNC control to zero and note that the pattern begins to drift on the screen. Advance the control until the sine wave pattern is stopped. At this setting, enough synchronizing voltage has been supplied to the sweep oscillator from the vertical input, to lock the oscillator in step with the applied 60-cycle voltage. (Over-synchronization is to be avoided, to prevent the possible introduction of distortion in the waveform produced on the screen.) Note that this synchronization is obtained with the SYNC switch set to the INTERNAL (INT.) position. When this switch is thrown to the EXTERNAL position, the sweep oscillator may be locked-in with a voltage applied to the EXT. SYNC binding post. (The Dumont 208B model has an additional LINE FREQUENCY position on the SYNC. SIGNAL SELECTOR switch.)

(c). *Producing More than One Complete Cycle on the Screen* is accomplished by lowering the sweep frequency to a submultiple of the frequency being applied to the vertical input. This is done for this frequency, by setting the SWEEP RANGE switch back to the 15-cycle position, and advancing the SWEEP VERNIER setting from zero. As many as 6 full cycles can be made to appear in the pattern when the sweep frequency is adjusted to a value as low as 10 cycles. However, since there is an objectionable flicker at this low rate of sweep recurrence, it is better to advance the sweep frequency until only 3 or preferably 2 cycles appear on the screen. (These patterns would occur when the sine wave is stopped at the respective

sweep frequencies of 20 and 30 cycles.)

4. *Repulsion of Electron Beam*: This can be shown easily while any pattern is on the screen, by electrifying a small portion of the celluloid calibration screen covering the cathode-ray tube opening. When this celluloid is gently rubbed, the electrostatic charge produced, (negative), will repel the electron beam, causing the spot producing the pattern to move away, temporarily, from the locality of the like charge. As the charge leaks off, the screen pattern reappears.

5. *Pattern Showing Two Complete Cycles*: Decrease the sweep frequency by retarding the SWEEP VERNIER control to the left until a pattern showing 2 cycles is stopped on the screen as illustrated in Fig. 5-b. Note that this pattern is obtained when the sweep frequency is one-half the applied frequency. (The same result would be obtained, for example, when a 120-cycle voltage is applied to the vertical plates and the sweep frequency is adjusted to 60 cycles.)

6. *Stray Pick-Up*: Remove the voltage being applied to the vertical plates, and test for stray pick-up by touching the finger to the "V" binding post, with
(Continued on page 505)

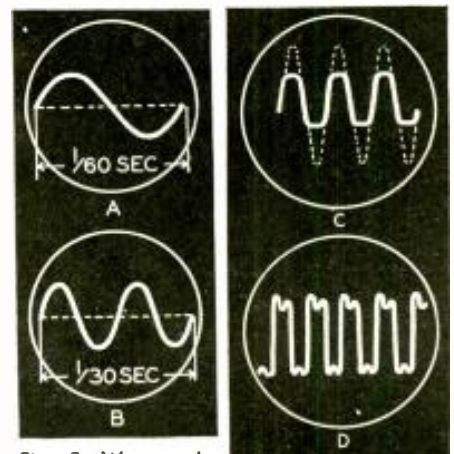

Fig. 5—Wave patterns with linear sweep. A—Sine wave, 60-cycle sweep. B—Same, 30-cycle sweep. C—Saturation and distortion from overload. D—Harmonic distortion caused by wrong bias.

NOW—A RADIO PEN

By MOHAMMED ULYSSES FIPS, I. I. R. R. E. E.*

NOT so long ago, the Boss-Editor called me into his sanctum, handed me a big cigar and, with one of his rare smiles, asked me to be seated.

I immediately observed that the cigar was not one of the Chief's usual stogies, but an expensive import, which I knew to be the brand of one of our big advertisers who goes in for fancy cigars.

"Fips, my boy," began the Editorial Oracle, "we have a most important project before us today which requires immediate and concentrated attention. One of our top advertisers, the Utis Electronic Corporation, who, as you know, use page advertisements right along, wishes to go into production as fast as possible on a new radio set. This innovation is nothing less than a new miniature radio which is to be called the *Radio Pen*."

"This particular radio must be the size of a fountain pen, not longer than six inches, and small enough to be carried in the upper vest pocket alongside a fountain pen and pencil.

"I have worked out all the preliminary details, as you will see from the detailed sheet, which I hand you here—

*International Institute Royal Radio Exegetic Engineers.

with. This is only a rough sketch giving you but a mere outline what our advertiser wants. They have asked us to do the work for them, inasmuch as all their good engineers are still in Uncle Sam's service and will not return for some time. I immediately felt that

Based on formerly secret circuits and tubes, this radio is here described for the first time in any magazine

the only radio engineer qualified to do the job justice would be you."

Here The Boss handed me another cigar—a most unusual occurrence—which I took as a great personal compliment and I stammered my thanks.

The All Highest then went on to say that the model would have to be ready in thirty days, and to hurry the project under forced draught, day and night at full speed. I was to keep track of all expenses carefully and confer with him at least once a week until the Radio Pen was completed.

The Mahatma then made some unusual—for him—compliments on my past work and wished me luck. (He didn't give me another cigar.)

Everything went well and after long, heartbreaking weeks, the

The Radio Pen in use. It is strongly reminiscent of the world-famous Handie-Talkie of World War II.

The Radio Pen is put into action by switch at bottom, just above tuning knob. Earpiece projects from the side.

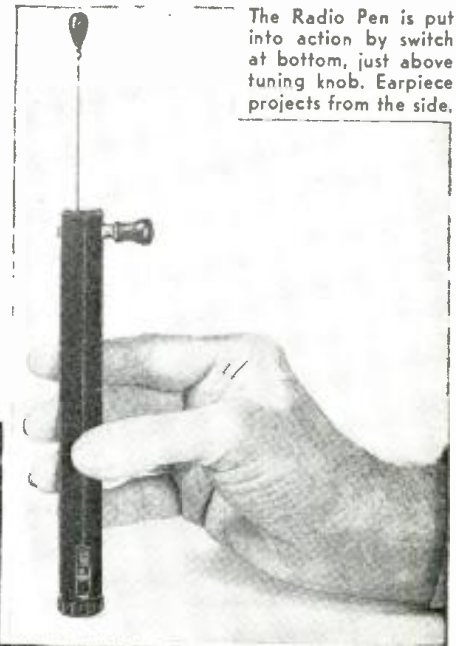

Radio Pen was duly evolved. Indeed, I take the greatest pride in this unusual development, which, to the best of my knowledge has not been attempted before. It becomes immediately clear to any radio engineer that there are numerous difficulties to overcome in engineering a workable radio set in the small space of a normal pen. Nevertheless, the problem was brilliantly solved as will be apparent from these pages.

Not only was the Radio Pen engineered in the space of thirty days, but the Utis Electronic Corporation went into immediate production of this intricate new radio. This will be seen from the photographs which appear here.

As the photographs attest, the Radio Pen measures approximately six inches without the extended aerial. The latter measures another six inches when fully extended. Normally it is pushed into the "pen" and takes up no room, except the small top knob which extends slightly. The pen measures 3/4-inch in diameter and, therefore, fits the vest pocket; it can also be carried in a lady's purse. It only weighs three ounces.

The Radio Pen was not designed as a loud-speaking radio; it is of a purely personal type. The earpiece which extends slightly, is placed in one's ear, then the bottom switch is pushed, which instantly puts the set into operation. Tuning is done by the bottom wheel in the usual way. The Radio Pen covers the full range of the broadcast band.

The illustrations give full details and the circuit diagram also makes everything clear to the radio man. There are a number of technical details, which I would like to enumerate here.

In a small instrument of this type, it becomes apparent that there is not sufficient space available for a regulation "chassis." Instead, I used a central support, which in this case is a plastic



rod 1/16-inch in diameter upon which the top part of the set is built. There is a similar supporting rod for the bottom. As the set is built, it is held together by two "chassis wires," which run around all the components as clearly seen in one of the photographs. This gives the set not only compactness, but makes the entire "chassis" rigid.

The circuit, as you will note, is a four-tube superheterodyne, which follows conventional engineering practice.

I use a special crystal speaker, which gives clear reproduction and brings in local stations with excellent volume. The tuning condenser is of the compression variety, with certain novel refinements. As several patents are pending on this particular phase, I cannot here give the exact details of the development. As will be noted from the illustrations, as well as the circuit diagram, *only an "A" battery is used for power purposes. THERE IS NO "B" BATTERY.* I found that this was a necessary requirement, simply because there was no space available for a "B" battery; even the new smallest type was too big.

The "A" battery is the new and modern mercury-oxide type. It gives longer service than the ordinary carbon type battery. This new battery, incidentally, was used extensively during the war as, for instance, in the famous Radio Fuze,

described in RADIO-CRAFT in the December 1945 issue.

By inspecting the circuit diagram, it will be seen, immediately, that as far as the power supply is concerned an entirely new engineering principle had to be evolved. Inasmuch as no "B" batteries are used, but as it is necessary to have a tension of at least 90 volts, in order to operate the vacuum tubes, I have recourse to a new radio principle, used rarely for high voltage, low-current purposes. This I term "Electronic Power Regeneration." The following gives an outline of the principle:

The receiver is so designed that every tube, except the power-generating tube itself, works on the resistance principle. To this end, a crystal earphone is used in the output circuit, so that even this stage is resistance-operated. Thus currents are lower—and voltages higher—than in the usual portable radio.

The one special tube in the circuit (V1) is an oscillator-rectifier. It is so designed as to oscillate readily on the three volts supplied by the uni-battery. The oscillating circuit, as will be seen from Fig. 1, is part of an r.f. auto-transformer, high-voltage output from which is fed into the rectifier section of the tube. Filtered by the r.f. choke, RFC-1, and condensers C1 and C2, d.c. at a voltage of approximately 180 is supplied to the other tubes.

The electronic generator tube, V1, is of a gas type. Sufficient free ions are generated in the rectifier section to materially reduce its internal resistance without producing complete ionic breakdown of the gas, which would prevent oscillation. Thus larger currents can

A Pen differs little in size from the device after which it was rather fancifully called.

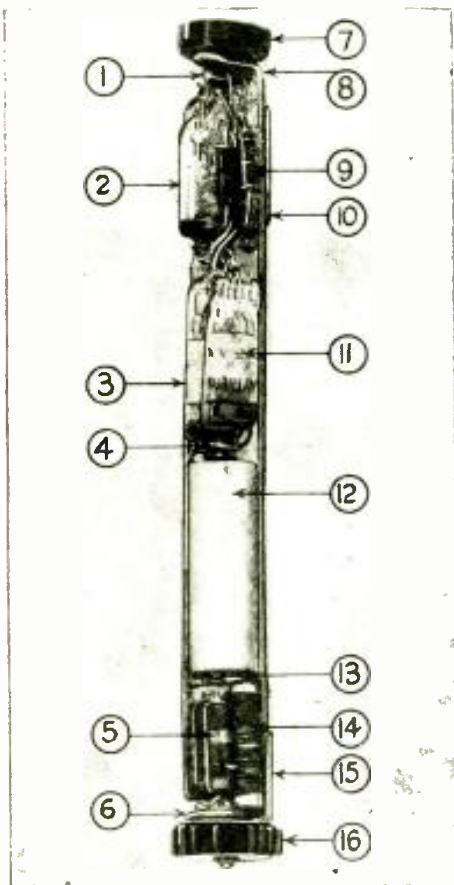
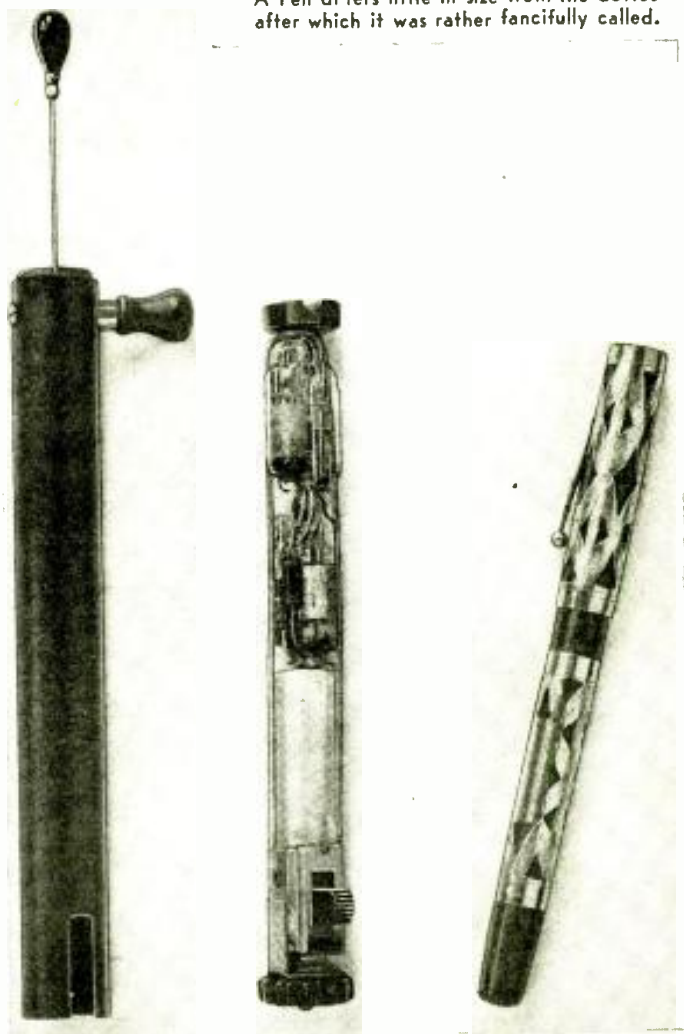

Chassis of the Radio Pen. 1—Coupling piece of speaker which contacts external earpiece. 2, 3, 10, 11—Miniature vacuum tubes. 4—Connector for batteries. 5—The condenser block. 6—Tuning condenser. 7—Miniature crystal speaker. 8—Chassis and ground wire. 9—Condenser block. 12—Battery block. 13—Bottom battery connector. 14—Primary tuning inductor. 15—Aerial connector. 16—Tuning wheel. The entire "chassis" is rigid and all parts are removable for replacement.

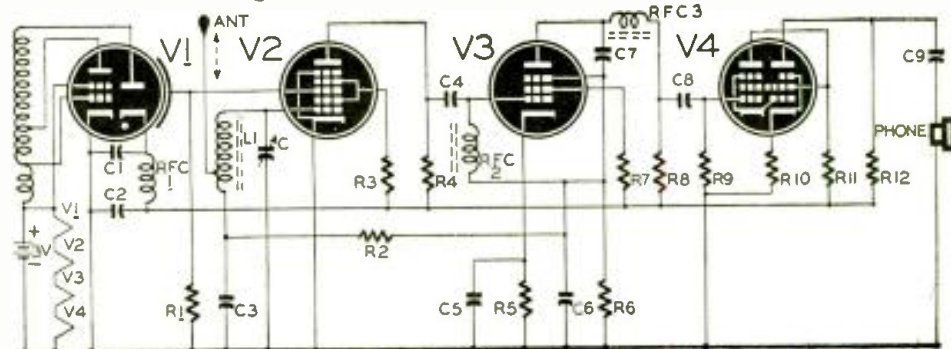

Fig. 1—Schematic of the Radio Pen. Tubes are the new ultra-midget sprayed-cathode type.

RADIO TO THE MOON

Lt. Col. John DeWitt, the first man to send signals across cosmic space, tells how he did it. The cover shows the Colonel and a part of his radar apparatus.

THE Signal Corps' nationwide announcement on January 25th that the first earth-to-moon contact had been made by radar was not the result of a few weeks experiment, but of long-term thinking that began as early as 1940. We reasoned that there might well be no theoretical limit to the distance our ionosphere-piercing signals might travel, and therefore no theoretical straight line limit to the protecting umbrella of our military radar.

Our contact with the German Luftwaffe proved this. The higher the enemy raiders approached, the better our radar worked. From the start, in fact, the operation of radar outpaced the ceiling of high-altitude planes, and far exceeded the vertical travel of man's most powerful anti-aircraft shell.

This led us to rightly reason that we had an instrument which, being used for the very vital mission of saving lives,

was nonetheless realizing a small fraction of its potential use.

If, overnight, the enemy had evolved a very high-flying plane, even our wartime radar could have coped with it. Chances are it will be a long time before such a plane will be produced, indicating that radar science is so far ahead of man's propellent knowledge that no tests on a par with its space-piercing ability are as yet available on earth.

This thinking led us to the next logical target 238,000 miles away — the moon. When we broke through to this satellite at two minutes before noon on January 10, just as it cleared the horizon, we knew we had broken through the encircling ring of the ionosphere. A priceless bit of information—that our signals could and were piercing the void of ether between planets—was ours!

(Continued on page 501)



Lt. Col. John DeWitt was born 40 years ago in Nashville, Tennessee. He has been active in radio for 20 years, during much of which time he was one of the South's leading amateurs, W4ERL. On the professional side, he was chief engineer of Radio WSM and its sister FM station W47NV, at Nashville, from 1922 to 1943. Later he was with Bell Telephone Laboratories, engaged in telephone research.

Commissioned as Major in June, 1943, he served with the Electronics Branch of the Engineering and Technical Service of the Office of the Chief Signal Officer, and later as director of the Camp Evans Signal Laboratory. In this work he was responsible for direction of a large number of projects on important weapons for the ETO, perfecting among other devices several types of equipment for locating and pin-pointing enemy mortar fire. Favorite hobbies, as of 1943, were amateur astronomy and amateur radio. Is also an inveterate hunter and hiking enthusiast.

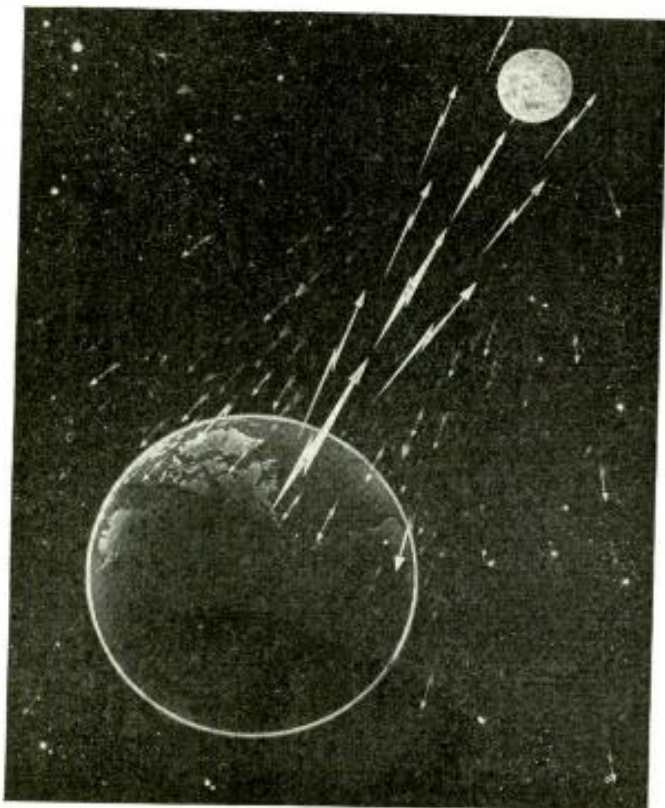

Radar Signals leaving Belmar to the moon, and echoes reflected in scattered fashion to the earth and into the space surrounding it.

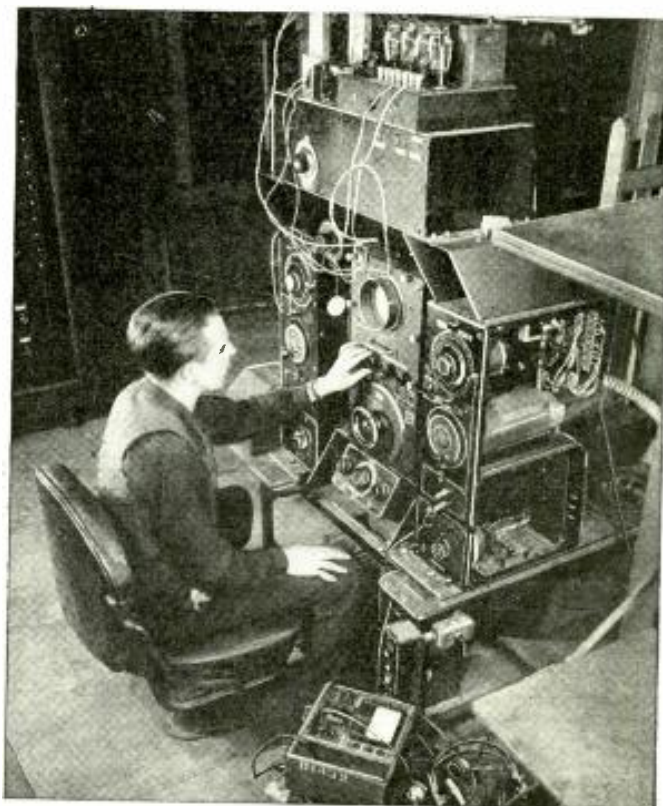

Selsyn devices for keeping the antenna array firing on the moon. The very heavy oversize array required unusual apparatus to turn it.

A TROUBLE CHASER

A small signal tracer with plugs and jacks for switches

THE trouble chaser described in this article can be very useful to the radio servicemen, whether beginner or expert. This small tester will check signal from the first r.f. coil to the voice coil of any radio receiver. The switching arrangement is such that stages of the trouble chaser can be substituted in the defective set. It can be also used as an audio amplifier for testing phono pickups, microphones, and other audio devices. There are only two leads to attach to the defective receiver. The circuit appears in Fig. 1.

The unit is portable, with detachable cover, so that it can be used on the service bench or for outside work. The cabinet dimensions are: 9½ inches long, 7¼ inches high and 4 inches in depth. An overseas metal mailing case was used as a container. Since the metal was rather thin, the sides were reinforced with ¼-inch thin pine wood boards. The wooden sides were nailed to the metal container with small finishing nails so the surface would not be bumpy when covered with black covering material.

The outside of the metal box was covered with black chair-topping material which was purchased from a local furniture dealer. First, fit the leatherette around the metal container and cut the material before applying it. This done, ordinary glue (or in the author's case, burlap glue) can be used, applying glue to both surfaces and letting this set until the surfaces are sticky. Then apply the black topping to the metal container, being sure to pull and wipe all of the wrinkles out of the leather material. Let the box dry for about twelve hours before doing any work upon it.

It is best to bring about one full inch of material inside of the box so that when the test panel is placed in position, the pine boards will not show. The ends of the material can be tacked down if the glue will not hold them.

Two small ½-inch pine boards were

placed vertically on both sides of the box to remain as a mounting bracket for the front panel. These small boards were placed ¼ of an inch from the front of the container and fastened with two small wood screws at each end. A dime store black and chrome handle was bolted in the center of the box, setting off the signal tracer like a commercial test instrument.

The metal lid was not covered, although it could be covered from the same material as the container. The pin was removed from the metal hinge and the end of the hinge sawed off so that the cover would be detachable. Then the remaining pin was soldered to the other piece of metal hinge.

THE FRONT PANEL

The front panel was constructed from three-ply walnut veneer, 8¾ inches long and 6½ inches high. An outline drawing is shown in Fig. 2, giving all the required dimensions. All holes were drilled and the speaker grille cut before the panel was finished. The panel was sanded down and all markings finished before giving an overall layer of varnish (Duco type).

Be sure and mount all the small jacks and parts before attaching the chassis. It can then be screwed onto the front panel with wood screws. Do not mount the speaker until the wiring is complete. It is very easy to puncture the speaker cone otherwise.

CIRCUIT DESCRIPTION

The apparatus was revamped from a midget t.r.f. receiver that was out of order. Only a new tube and a few extra parts were needed, so the signal chaser was inexpensive and simple to build. The first tube or stage is a 12SK7 used as an r.f. amplifier, with cathode bias. The same old variable condenser and antenna coil

were employed, although only one section of the condenser was used. After the first r.f. stage, a 12SQ7 rectifies and amplifies the incoming signal. In both of these r.f. stages, it is possible to use the internal signal or the signal from the defective receiver by a special switching arrangement with phone tips and phone plugs.

All radio frequencies should be out of circuit by the time the signal reaches the control grid of the radio amplifier. A .00025-mf mica condenser by-passes

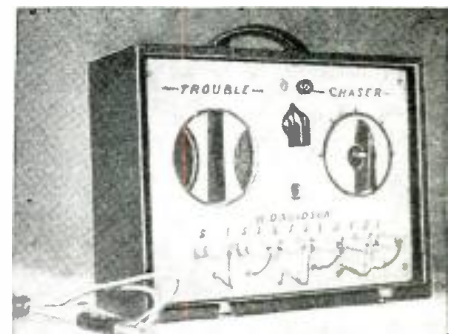

How the Trouble Chaser looks in its cabinet.

r.f. energy to ground at the plate of the 12SQ7. This audio signal is then coupled to the last audio amplifier with coupling condenser C1.

The final audio amplifier is a beam power output tube using cathode bias. It is possible at this stage to apply any outside source of audio power to be amplified, such as a phono player, small receivers, pickups, and microphones. Also, in the plate circuit of the 50L6-GT is another plug tip switching arrangement, so that another receiver's speaker can be tested, including output transformer and voice coil.

A 35Z5-GT rectifier tube is used in (Continued on page 504)

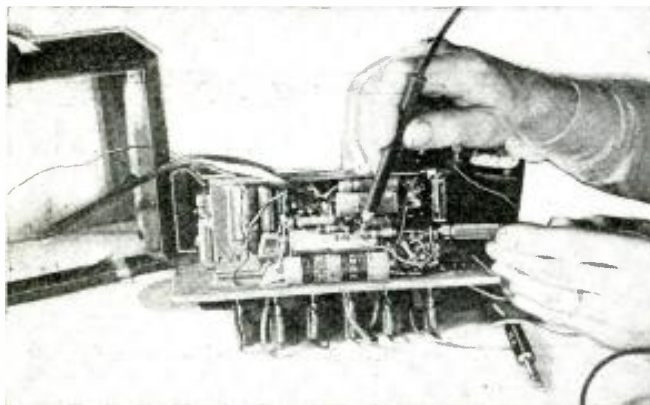

Tracking down a little difficulty in the Trouble Chaser itself.

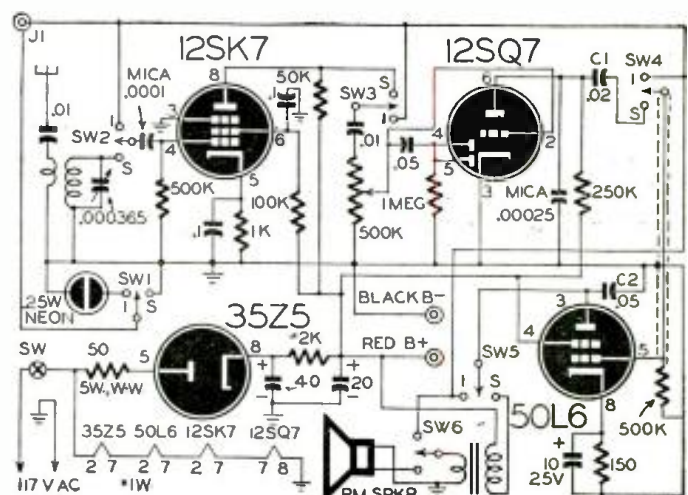

Fig. 1—The circuit. S switch position is radio (set). I stands for input.

32-VOLT RECEIVER

Designed and Built for the Low Voltage

ALL voltages—heater, plate and screen—of the receiver shown in Fig. 1 are obtained directly from the 32-volt d.c. line.

Performance is much better than might be expected from a set with such low plate voltages. The sensitivity compares to that of an average a.c. receiver. Stations on both coasts have been logged, using only a 20-foot antenna. Selectivity is very good, as might be expected, because of the r.f. stage and the superheterodyne circuit. Quality of reproduction is superior to that of most battery receivers. Power consumption is very low, less than 50 watts, one-fourth to one-half that required by the usual receiver which gets high plate voltages from vibrators or motor generators.

Surprising as it may seem, the 6-volt series of tubes work much better than the 1.4- or 2-volt battery type, as de-

only bias used, the low plate voltages rendering cathode bias unnecessary and undesirable. Hi-Q iron-core coils were used in all the r.f. (and indeed the i.f.) circuits, to keep efficiency of the tuned stages at a maximum. This compensated for the low gain of the tubes at the voltages used.

CIRCUIT DETAILS AND ADAPTIONS

The oscillator-first detector was a 6A8, as tests showed it to be the most satisfactory type for the low electrode voltages used. The oscillator is extremely strong. Plate voltage could be dropped to 20 before it went out of oscillation. Several types were tried before the 6A8 was finally adopted. (Battery tubes were the poorest, unless filament voltages were raised to an unsafe value.) To operate the 6A8 with best results at 32 volts, it is necessary to raise the grid condenser and resistor values over those conventionally used. No trouble with parasitics was encountered in this circuit.

The oscillator coil was of the adjustable-iron type commonly used for replacements. These take a little time to adjust, but are a great improvement on the non-adjustable type, as the oscillator can be made to track at three points on the dial instead of only two. Adjusted at 600 (padder) 1000 (coil) and 1400 (trimmer) kilocycles, tracking was excellent all over the band. No a.v.c. voltage was used on the 6A8.

One intermediate-frequency stage was sufficient when hi-Q i.f. transformers



Lyle Treakle was born thirty-three years ago, "a native son of Minnesota's Twin Cities." Has been "in radio" since the age of ten, when he started making crystal sets, later switching to the Audion.

Largely self-educated, he found mathematics particularly fascinating, and has built up a library of new and second-hand books on the subject. At present Chief Instructor of the Western Radio Institute, he served with the Submarine Signal Co. as Sonar engineer during the war. While he has operated his own shops, the business end of servicing never interested him.

Always an exponent of speed in radio work, Mr. Treakle occasionally demonstrates what he means by Rapid Radio Servicing. He got his present job by turning out 49 radios in eighteen hours; run-of-the-mill radios, but some of them sufficiently tough to have stuck men who are considered "tops" in the area.

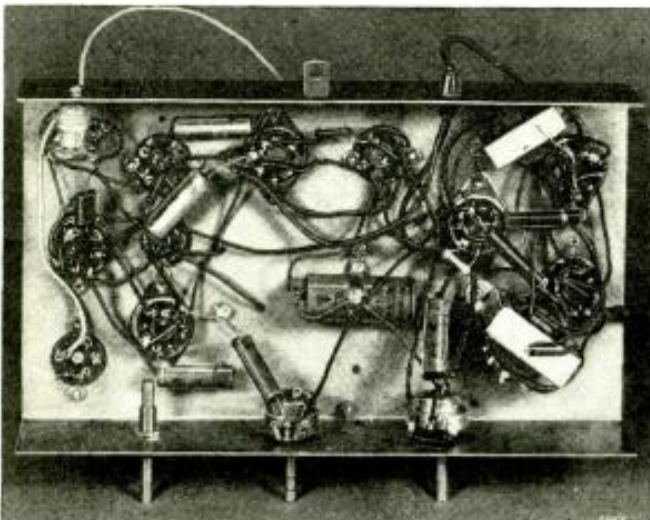

An under-chassis view. Wiring is simple, as in all d.c. receivers

terminated by actual comparison. 25L6 output tubes were found most satisfactory after trying many types, including even the old 48.

The radio-frequency stage was included to keep hiss from the mixer to a minimum. The hiss was strong enough to be annoying before this stage was added. It also reduces image interference to the vanishing point.

Gain added by the r.f. stage was valuable, as the radio must be used for distance. More straight gain could of course have been obtained by adding an i.f. instead of an r.f. stage, but the other advantages more than offset any sacrifice of gain made by using it in preference to an i.f. stage.

Automatic bias control was applied to the r.f. and i.f. stages. This was the

were used. On the first model two stages with ordinary coils were tried. It gave only slightly more gain than the one-stage model with iron-core high-gain coils. As with the r.f. stage, no grid bias other than the a.v.c. was applied to the single 6K7 i.f. tube.

The diode section of the 6R7 acts as a conventional detector, and supplies a.v.c. The volume control—a 1-megohm unit—acts as the diode load resistor. An r.f. choke was used to filter out radio frequency instead of the resistor more commonly used. The loss of audio voltage through this (normally 50,000-ohm)

(Continued on page 514)

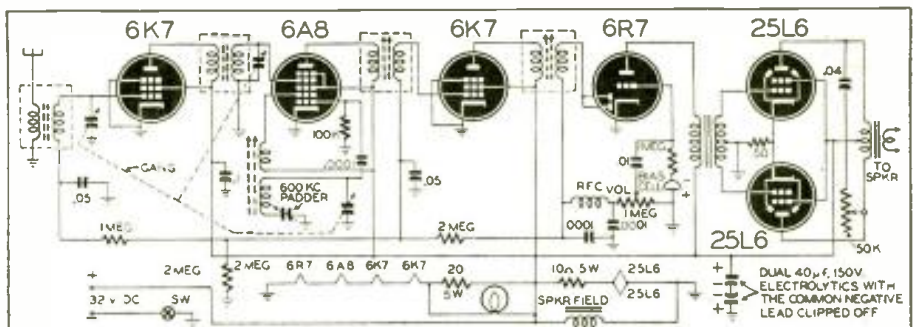

Fig. 1—Schematic of the receiver. Note the filter condenser connection for dual polarity.

FIVE NEW CIRCUITS

"Liberated" German receivers show interesting features

THE writer recently had the opportunity to examine five foreign midget radios, and was impressed by their unusual variation of the average circuits, or chassis layout, plus unusually good results from the number of tubes employed.

All the receivers had been very much "worked-over" since original produc-

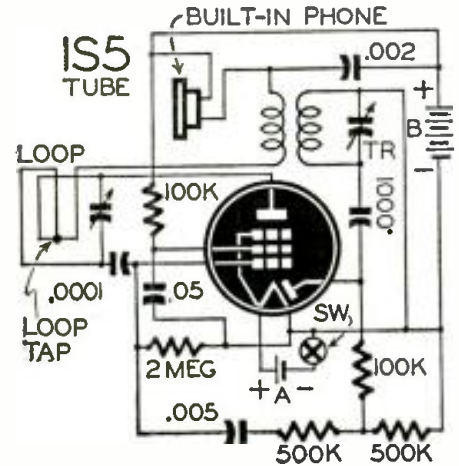

Fig. 1-a—Fixed-tune 1-tube superregenerator.

tion, and it was surprising that they functioned at all, but function they certainly did, and with excellent results.

The need of such tube shielding had made itself felt in the repaired sets due apparently to the closely-spaced

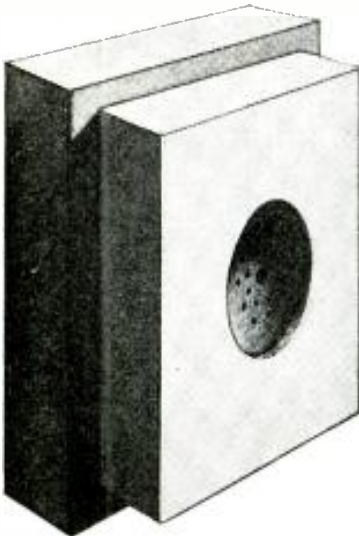

Fig. 1-b—Physical layout of the 1-tube set.

components in all the receivers. This shielding had been done by coating all the tubes with aluminum paint and then grounding the paint with a grounded bare wire wrapped around each tube. The batteries are in the rear, larger portion of the case.

The first, and simplest, receiver is the only one in its original case, probably because it could be so easily protected owing to its small size. There was no name on the case.

It is a pocket-portable receiver, with self-contained batteries, in a case approximately 4½ x 3½ x 1¼ inches. The circuit (Fig. 1-a) is a one-tube superregenerative reflex, using a 1S5 tube, (a diode-pentode combination), with a penlite-size 1½-volt A, and a 22½-volt hearing-aid size B battery. A loop antenna is wound around the outside of the case, which is of thin wood, and the whole is covered by a leatherette material. The case is recessed as illustrated in Fig. 1-b, and the loop antenna is wound on the recessed portion. Thus when the set is held up to the ear for reception on the built-in phone, the fingers of the hand do not actually rest on the loop antenna, and so do not affect the inductance. Position of the built-in phone is also shown in this illustration, as is the "on-off" switch, which is the only control this tiny set has. Volume is controlled by the directional properties of the loop antenna, and tuning is done by pre-set trimmer condensers.

Apparently the set was designed as a receiver for the strongest local station only, probably a "Propaganda" or "News" station, as no provision is made to reach the trimmer condensers from outside the case.

Construction and operation of such a set would be quite straightforward, but the value of resistance in the screen circuit would have to be experimented with to the point where the screen-voltage is as high as possible without causing audible oscillation, or "whistle." Results are loud and clear when the correct value is found.

The only metal part of the receiver is a metal front-panel, which has a hole about one inch in diameter in it, behind which is mounted the built-in phone, with the other components grouped around it. The batteries are in the rear, larger portion of the case.

UNORTHODOX TWO-TUBER

The second receiver (Fig. 2) is a two-tube superhet, using a 12SA7 and a 70L7-GT. (Note that the 12SA7 is not the "GT" type, as in this latter type the suppressor grid is internally connected to the cathode, which would make it unsuitable for this circuit.) The 12SA7 acts not only as a converter, but also as a detector and 1st audio amplifier, with the 70L7-GT as 2nd a.f. and rectifier. This triple function of the 12SA7 is accomplished by feeding the i.f. output through an i.f. transformer to the suppressor grid which then acts like a diode detector, the rectified voltage of which is then reflexed through the antenna loop winding into the antenna grid, the tube then acting as an audio amplifier. (The only circuit that the writer has knowledge of that is in any way similar to this, is one recently given in *Radio-Craft*, in which the suppressor grid of a 6SK7 was used as a detector, the tube acting as a reflex i.f., detector and 1st a.f.)

The tuning condenser is unconventional. Though it consists of the usual 365 mmf. 2-gang type, it has only the antenna-section trimmer in parallel with the condenser proper, the oscillator-section trimmer being in series. It is somewhat larger than usual and acts as the oscillator series padder condenser.

A 3½-inch magnetic speaker is used, and rectifier output smoothing is provided by a small-size (but large capacity), dual electrolytic condenser, about 20 mf per section. This condenser has a tightly fitting outer shell

(Continued on page 494)

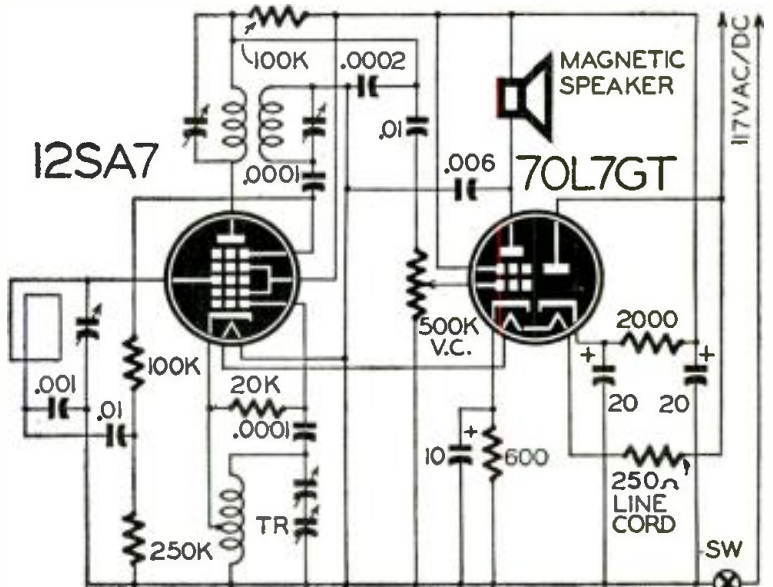

Fig. 2—This two-tube receiver employs a superheterodyne circuit.

LANDINGS BY RADAR

The author describes advantages of radar ground control

ONE of the benefits of World War II is the solution to aviation's greatest handicap. Through the magic of radar, we have now overcome the danger of flying in bad weather.

Two billion dollars was invested in atomic bomb research, and this expendi-

as worked out by Gilfillan.

The Search System employs a radar beam covering a radius of 30 miles in every direction, enabling the operator to actually see, upon a television-like (PPI) indicator, every airplane, mountain, building, or other obstruction in the entire area. Thus the distance and

act position in elevation, azimuth, and distance with respect to the runway.

By carefully watching the plane's progress upon the map-face of the precision indicator, the operator guides the approaching aircraft safely past obstacles, corrects the pilot as to course, elevation and speed, and "talks him down" to a safe landing.

A typical radar-controlled landing might occur as follows:

A pilot caught in fog or bad weather without sufficient gasoline to divert to an alternate field, reports to the Airport Control Tower that he is flying west at an elevation of 4000 feet, and requests assistance in making an emergency landing on instruments. The Control Tower operator, seeing the plane on his search radar scope, advises the pilot that he is 26 miles due east of the field, and that he is cleared for a "straight in" approach on runway 27. He instructs the pilot to descend to 2500 feet and continue flying west on a heading of 270 degrees. After maneuvering the plane to a point ten miles from the field, he instructs the pilot:

"Your range is now 10 miles. Your present heading is good. Prepare to land. Reduce air speed. Partial flaps. Wheels down. . . . Reduce altitude to 1500 feet."

When the plane is six miles from the field, its radar image appears on the high precision radar scope. The controller can now give the pilot precise

(Continued on page 508)

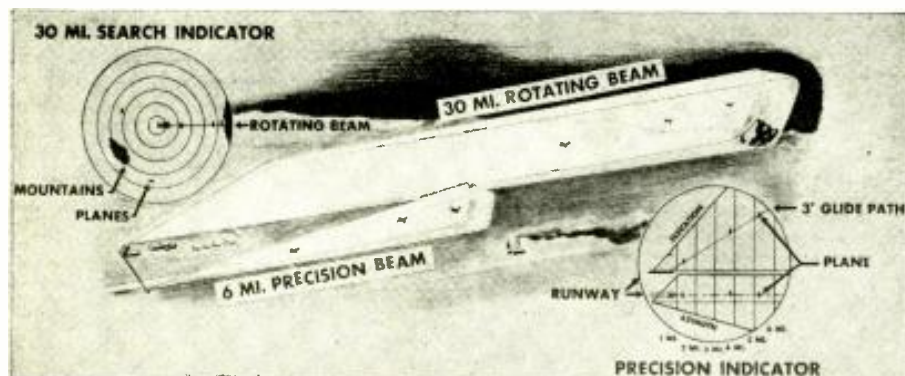

The long-range rotating beam detects aircraft and the 6-mile precision beam guides them in.

ture successfully ended the war. Not so well known is the fact that three billion dollars was invested in radar research. The results of this research was one of the major factors in keeping this country and our allies in the war. Most of us are familiar with the radar gun director which saved England from the full force of the V-1 buzz-bomb attack; with Mickey, or the bombing-through-overcast radar, which enabled our planes to pin-point bombs on enemy targets in darkness and through clouds; with airborne and ship radar, which helped defeat the submarine menace.

Most of these radar devices lost their usefulness on V-J day. One of the few radar discoveries which have peacetime importance is *Radar Landing Control*, or *Ground Controlled Approach (GCA)*, as the military version was known. This device was hurriedly perfected to meet a desperate need in the hectic days when we were trying to bomb Germany to her knees. American and British Air Forces Headquarters were greatly disturbed by the fact that our planes were incurring as many casualties on returning to base and attempting to land in darkness and bad weather as they had suffered over enemy targets due to flak and Nazi fighter planes.

This military version of *Radar Landing Control* consisted of a Search Radar System and a Precision Radar System. Both of these features are retained in the commercial model, described below,

*Radar Division, Gilfillan Bros. Inc., Los Angeles, California.

bearing of an aircraft is determined with pin-point precision. Through radio communication with the pilot, the operator directs the plane to a particular position about 10 miles from the airport.

When the aircraft has been brought to this point, the operator turns to the Precision Radar Scope. Two sharply defined radar beams present an expanded view of the approach area upon the Precision Scope, showing the aircraft's ex-

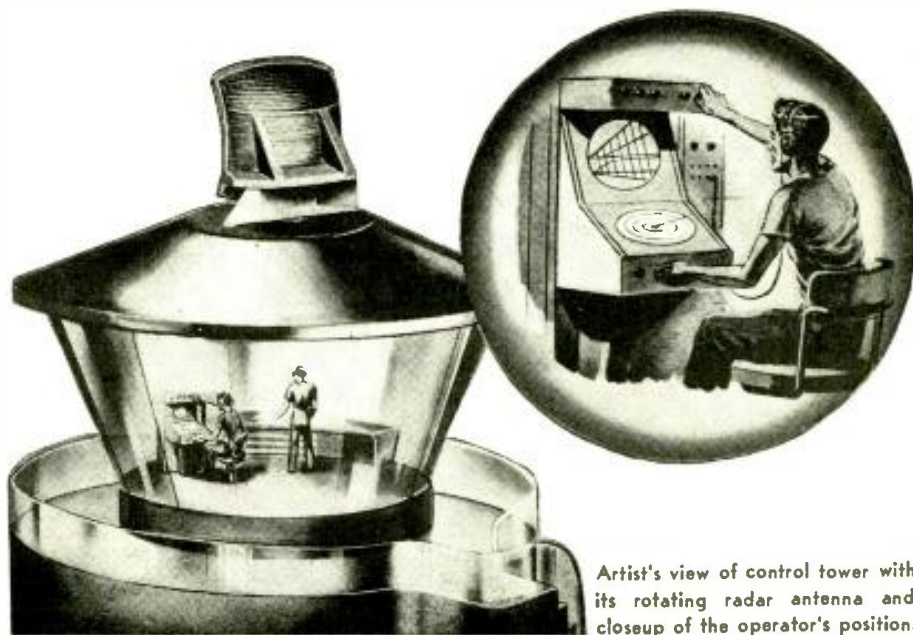

Artist's view of control tower with its rotating radar antenna and closeup of the operator's position.

VERTICAL RHOMBICS

Are Excellent Antennas When Frequencies Are High Enough

THE following notes were compiled as a result of observation of Vertical Rhombic Antennas after two months experimentation in using them as radiators for v.h.f. at distances beyond normal line-of-sight.

1. The vertical rhombic, though cumbersome, unruly and hard to handle, showed definite advantages over two- and three-element horizontal and vertical arrays in a distance of 90 miles from an altitude of 200 feet. This distance is several miles beyond line-of-sight. While operating and maintaining military telephone across the English Channel,

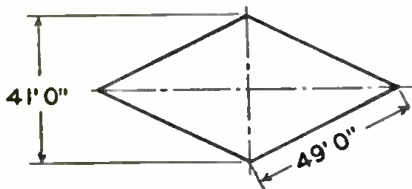

Fig. 1—Rhombic dimensions for 3 to 4 meters.

teletype, radio circuits, at 3 to 4.2 meters (70 to 100 mc) with both 1505 (Link) and AN/TRC-1 (Link) equipment, two-element vertical dipole arrays were used with excellent results except for fading and noise. Three-element horizontal arrays were also used but with the same difficulties. When using vertical rhombic antennas, however, the noise was eliminated almost completely and the fading reduced to a minimum. Some fading was experienced. However, results from rhombic operation were very much more dependable than with the other two types of antennas.

2. The rhombics used were all constructed in the field by the author. After some experiment I arrived at the following facts:

A. The best length for rhombic for 3 to 4.2 meter operation is: Each leg 49 feet; mean distance (top to bottom) 41 feet (see Fig. 1).

B. The best wire is no. 14, 12 or 10, single strand copperweld. The internal d.c. resistance of copperweld is higher, of course, but due to the tendency of r.f. energy to follow the outside of a conductor, loss due to resistance is negligible. Also the size of wire, 10, 12, or 14, being large tends to give high Q across the antenna. Copperweld wire is 60 percent steel, and is therefore unruly and hard to handle. Pre-straighten all wire used in construction of a rhombic to avoid unnecessary kinking and twisting. All kinks and twists which tend to reduce r.f. efficiency must be eliminated if the distance to be covered is long.

C. The best insulators are a question

to be argued. Polystyrene is, of course, the best r.f. insulator and should be used whenever possible, but since it is somewhat soft, it is not practical for the strain and stand-off insulators to be used with heavy duty copperweld wire. Heavy duty ceramic stand-off and strain insulators will be sufficient if kept clean. Cleanliness is always very important in r.f. insulators since "creeping" takes place when the insulators become dirty.

D. Feeders are the real headache of the vertical rhombic. The antenna is designed to be fed directly from a 600-ohm line. With most factory-built transmitters in use by the Signal Corps, however, this involves the use of a very complicated matching device, which requires considerable skill, material, and time to build. Hence, I eliminated the 600-ohm line and tied coaxial cable directly to the antenna. This gives us two problems of mis-match; both of which are easily solved with a little thought and some careful work.

BALANCING THE LINE

Problem No. 1: Coaxial cable is an unbalanced line, and must first be balanced before being of any value as a feeder for rhombic. I used this method of balancing the line: Take one half-wave length of coaxial and strip insulation from both shield and inner conductor at each end for a distance of five to six inches. Cut back shield to one inch. Leave one to two inches of inner insulation between end of shield and inner conductor. (See Fig. 2-a.) It is important that this insulation be kept clean.

Take the half-wave length of coaxial and make a loop so that the two ends come together as in Fig. 2-b.

Take the line to the transmitter and place stripped end alongside the stripped ends of the loop as in Fig. 2-c.

Solder the three shields together and tape; then forget them. We are concerned mostly with the inner conductors. Take the inner conductor of the transmitter line and tie it to one of the ends of the inner conductor in the loop. This connection is then attached to one side of the antenna (or stub which will be discussed later). The other end of the loop (inner conductor) is attached to

the other side of the antenna. The line is then effectively balanced. A simple and rough explanation follows:

1. The rhombic antenna is designed to be fed with the same value of energy to both sides. That is; at any point on one side of the antenna the instantaneous voltages (or current) will be the same value as the voltage (or current) at the corresponding point on the other side. Hence, the same amount of energy must be fed to both sides.

2. The second point to be remembered is that at any two corresponding points on the opposite sides the voltages (or currents) are 180° out of phase.

3. Before the loop was attached to the coaxial, the antenna was not being fed the same amount to both sides, due to capacity loss in the coaxial itself. In putting on the loop, we actually "grounded out" the shield or outside conductor—energy traveling up the shield of the transmitter line was confronted by a shorted half-wave loop which caused it to "buck" itself. Now for the inner conductors: One side of the antenna is attached to the line from the transmitter—to this connection also is attached one end of the half-wave loop—the other end of the loop being attached to the other side of the antenna. Thus we have the same value of energy at the two points, but due to the fact that the energy fed to one side of the

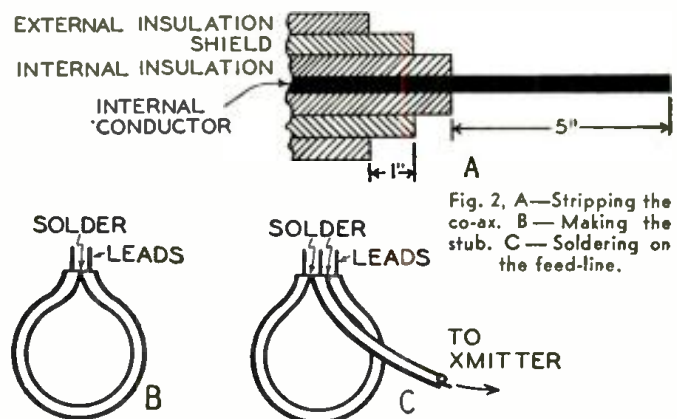

Fig. 2, A—Stripping the co-ax. B—Making the stub. C—Soldering on the feed-line.

antenna has to travel one-half wave length farther, the phase is inverted 180°.

MATCHING LINE AND ANTENNA

The next problem is the matching of the 70-ohm balanced co-ax to the 600-ohm antenna. Two methods were tried with good results. The first method used is the most simple, involving only the drawing down of the two ends of the

(Continued on page 509)

WAVES AND PULSES

Means of Producing Waveforms of Desired Characteristics

SQUARE waves, rectangular waves, and pulses are widely used in electronics, radar, and television. These wave and pulse forms supply split-microsecond synchronization between stages and circuits, and between isolated components. They time the radar pulse from transmitter to target and back again. They activate myriads of electronic control devices used in counting, sorting, measuring, testing, timing, and alarm equipment. They modulate r.f. carriers, synchro-

generally *but not always* being that portion of least duration. When a rectangular wave is of extremely short duration, it is then known as a pulse (Fig. 1-d).

Changes between maximum and minimum of these wave and pulse forms are usually considered—for purposes of simplicity—as being almost instantaneous. But this is not strictly true—for the same reason that perfect geometrical wave shapes are too difficult to obtain—because an infinitely large number of harmonics must be used to produce waves or pulses having perpendicular sides, flat tops and bottoms, and sharp corners. There can be only an approach toward perfection, the degree of geometric perfection being dependent upon the accuracy of the electronic work to be accomplished.

For example, some kinds of industrial electronic equipment will function quite adequately with rectangular waves having only a few high-order harmonics. The waves may have sloping sides, a peaked top, and little definition of duration.

On the other hand, in television and most radar circuits, a precise and well-defined wave or pulse form is an absolute necessity, requiring the presence of a large number of higher harmonics.

Thus, while the fundamental frequency of a wave or pulse recurrence may be somewhere in the audio range of only a few thousand cycles, in many cases the harmonics necessary for retaining the precise shape of the wave may extend well into the video range of frequencies.

A recurrent wave or pulse is always referred to by its basic or fundamental frequency of repetition. This is known as the *p.r.f.* or *pulse recurrence frequency*—the most important characteristic of a periodic wave or pulse form. The time of one cycle of operation is known as the *pulse interval* (Fig. 2). This is the reciprocal of the pulse recurrence frequency.

Rectangular waves and pulses are usually identified as either positive-going or negative-going, depending upon the *direction of polarity* (not the actual polarity) of the useful or leading edge of the pulse form. Thus, the series in Fig. 2 would be called positive-going pulses.

An important characteristic of a narrow wave or pulse is its *duration*

(Fig. 2), generally measured in milliseconds or in microseconds.

Amplitude of a wave or pulse can be measured in terms of voltage or power, depending upon a desired comparison with some other wave form. Ordinarily, these pulses are measured in terms of voltage.

Square waves, rectangular waves, and pulse forms *requiring high-order harmonic content*—i.e., with almost-perpendicular sides, flat tops, and sharp corners—are produced by a *series of wave-shaping electronic stages* arranged to affect and *reshape* a given input wave form according to the desired output.

Any number and arrangement of peaking, amplifying, limiting, or other wave-shaping stages may be used. Generally speaking, the larger the number of these special electronic stages, the more perfect and symmetrical will be the geometrical shape of the output wave or pulse form.

This arrangement of a *series of wave-shaping stages* is the principal means of producing wave and pulse forms having high-order harmonics.

However, some forms of *non-rectangular waves and pulses* can be generated by a single stage or circuit. Such waves are occasionally of use in industrial electronic and radar applications, where simplicity of design is more important than extreme accuracy of operation. These low-order harmonic impulses can be generated directly by a multivibrator, a blocking or squegging oscillator, a ringing oscillator, a transformer, or a saturable inductor. Operation of these special circuits will be discussed later in this article.

WAVE-SHAPING STAGES

Any arrangement or combination of wave-shaping stages depends upon the nature of both the *input wave form* to be changed and the *output wave or pulse form* desired. Each stage in the series must contribute directly to the final shape of the output wave or pulse.

Shape of a wave may be altered or influenced by any of several different electronic methods.

By utilizing the transient current ef-

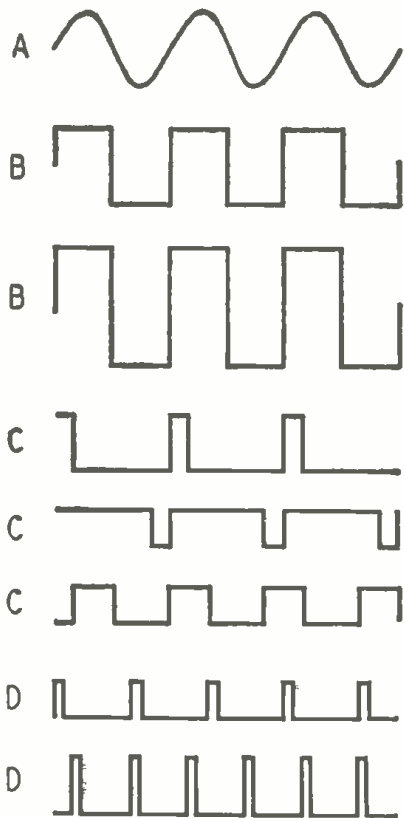

Fig. 1—Some recurrent waves and pulses. Fundamental sine wave appears at a, and square waves at b. Three forms of rectangular waves are shown at c, and two of pulses at d.

nize television signals, and perform a hundred other complex electronic duties.

Origination of these wave and pulse forms is a fairly simple matter, once a few basic principles are understood.

First of all, let's differentiate between waves and pulses.

A square wave (Fig. 1-b) has equal positive and negative alternations, with respective amplitudes about equal to length of alternations. A rectangular wave (Fig. 1-c) has unequal alternations, with the useful part of the wave

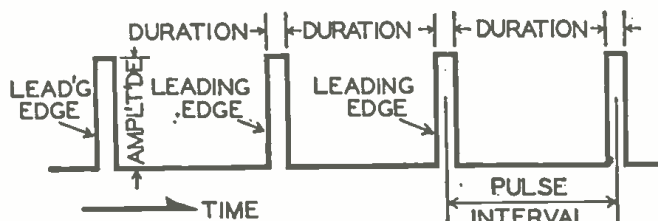

Fig. 2—Terms applied to the various parts of characteristic pulses.

fects of a simple R-C or R-L circuit¹ having a short time constant, any wave form (other than a pure sine wave) will be distorted. Greatest amount of distortion—known as *peaking*—is obtained when the input is a square or semi-square wave, consisting of abrupt changes. Thus, such an arrangement is sometimes known as a peaking stage.

A square wave is produced either by double limiter action or by means of an overdriven amplifier². The latter arrangement is particularly useful, since the output of an overdriven amplifier is rich in harmonic content.

Additional stages of peaking and limiting or squaring result in a square or rectangular wave having extremely high-order harmonics.

When a wave or pulse of certain duration is desired, portions of a peaked wave having the required duration are selected—and then limited and amplified without distortion. Occasionally, when a pulse output of very brief duration and low-order harmonics is desired, the extremities of a wave may be removed by limiter action² and further shaped or amplified.

Thus, by alternate stages of peaking, limiting, squaring, and amplification, a wave or pulse form having any desired degree of harmonic sharpness or duration or amplitude can be formed electronically and will appear in the output of the series of wave-shaping stages. The p.r.f. of the output wave or pulse will always be the same as the input frequency of alternation, since only the *shape* of the input wave is changed.

Many combinations of such wave-shaping stages are possible, an almost unlimited number. But, consistent with the nature of the available input wave and the desired output wave or pulse, the least number of stages should be used in order to conserve circuit power. Two typical arrangements of wave shaping stages are Figs. 3 and 4.

The circuit of Fig. 3 is required to convert a square wave to a rectangular output wave of short duration. Output must consist of high-order harmonics; that is, the wave form must have very steep slopes, sharp corners, and a flat top.

Conversion (Fig. 3) is thus effected:

The input square wave [A] from an external source is applied to a peaking or short-R-C circuit. This wave [B] then feeds two parallel diode limiters. The diodes are biased by about the same amount of voltage, thus removing positive and negative extremities of the applied wave which exceed the value of each bias. The limited wave [C] is then applied to a wide-band or video amplifier, where all harmonic components of the wave are amplified equally and without distortion. High-voltage output wave [D] of this stage then drives the grid of an overdriven amplifier, biased in such a manner that the output plate voltage swing [E] is of the required duration and is further

confined almost entirely to one polarity. Extremity of this polarity has sharp corners and almost-perpendicular sides. After removing unwanted portion of the wave [F] by means of a diode limiter, the extremity of the wave is applied to another wide-band amplifier. Amplitude of the rectangular wave

ponents receive equal amplification without distortion. This high-amplitude signal [C] is then applied to the grid of an overdriven amplifier or squarer, biased in such a manner that the output voltage swing is confined almost entirely to one polarity. Narrow duration of the wave is established by this

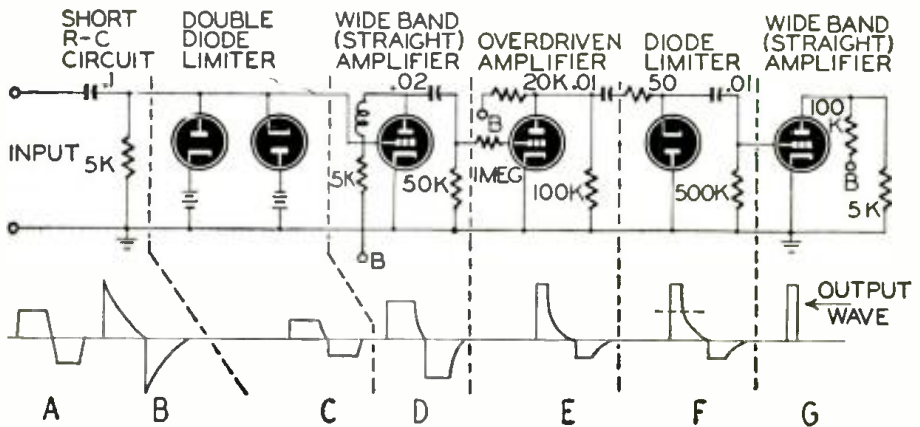

Fig. 3—Steps in the making of a pulse. A—Input to pulse circuit. B—Output of short R-C circuit. C—Output from double diode limiter. D—Output of straight amplifier. E—Output of overdriven amplifier. F—Limiter action of diode. G—Output, final straight amplifier.

is increased by this final amplifier, without affecting harmonic content or introducing distortion. Thus, the output wave form possesses the desired high-order harmonics and is of the required duration. Pulse recurrence frequency of the output wave, in this case, is equal to the frequency of the positive-going portion of the input square wave.

The circuit of Fig. 4 is required to convert a sine wave to an extremely narrow pulse. Output need not consist

stage. The voltage [D] is then fed to a biased diode limiter, which passes only the very narrow extremity of the wave. And this extremity [E] is the desired shape of the output pulse. Pulse recurrence frequency of this pulse will correspond to the frequency of the input sine wave.

Asymmetrical square waves can be produced in the output of an overdriven amplifier, because of the duo-limiting action of such a device when excited by an input voltage of extremely high am-

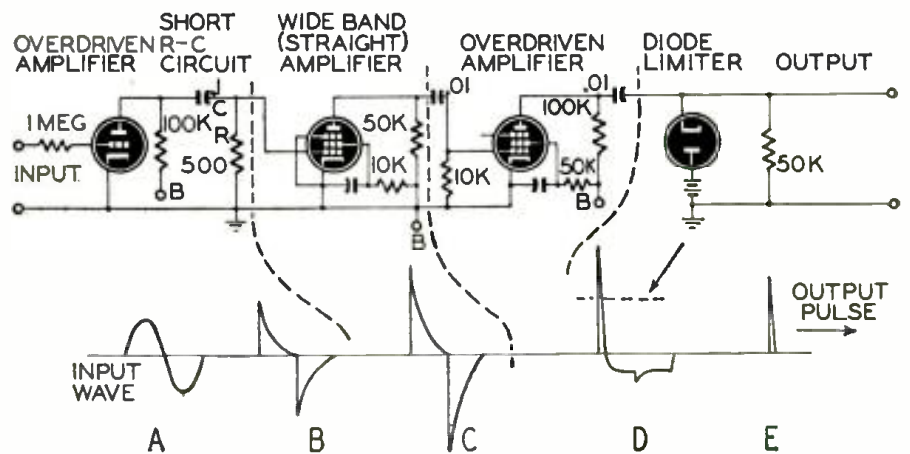

Fig. 4—Another pulse shaping circuit, producing pulses of slightly different shape. A—Input sine wave. B—Output of short R-C circuit. C—Output of straight amplifier. D—Output of overdriven amplifier, showing limiter action. E—Output of the diode limiter.

of high-order harmonics, since the brief duration of the impulse is of prime significance.

Conversion (Fig. 4) is effected as follows:

An overdriven amplifier changes the input sine wave [A] to a square wave of voltage, which is then applied to a peaking or short-R-C circuit. The peaked wave [B] is fed to a wide-band or video amplifier, where all harmonic com-

plitude. However, fairly asymmetrical square waves can be generated *directly* by means of a multivibrator.

Circuit of the multivibrator (Fig. 5) is essentially a two-stage resistance-coupled amplifier. The output of each of the two tubes is coupled to the input of the other.

Process by which oscillations are produced concerns the building up and
(Continued on page 498)

Note 1.—See "Electronic Transients," *Radio-Craft*, February, 1946.
Note 2.—See "Limiting Circuits," *Radio-Craft*, March, 1946.

SIGNAL TRACING METHODS

MODERN servicing by means of signal tracing is a quicker and surer method of locating trouble in radio receivers. It is unsurpassed for clearing intermittents. Especially is it useful to the beginner, as it not only helps make a servicing job easier but also permits the troubleshooter to hear what happens in various parts of the circuit.

Signal-tracing equipment can be comparatively simple and inexpensive, containing few hard-to-obtain tubes and circuit components. For this reason, a number of small signal tracers have recently been described in technical literature, or have appeared on the market. One such, the CA-11, made by Superior Instruments Co., is shown diagrammatically in Fig. 1 and illustrated in the photograph. It uses only a single tube, which is housed in the probe. With the exception of the phones, all parts are contained in a box 5x6x7 inches in dimensions. The 1T4 pentode in the probe is used as a triode with the screen and plate tied together. The 300 μ f

Since it is desirable to hear the signal quality as well as to measure the relative signal intensity, a switch is provided to disconnect the meter and cut in a pair of phones. The phones may be of any impedance above 2000 ohms but must be of the magnetic type. *Crystal phones must not be used as they will be damaged.*

Fig. 2 shows a standard 5-tube a.c.-d.c. circuit with the filament wiring and other irrelevant parts omitted. This circuit can be used as an illustrative example. Suppose the power supply has been checked and is found proper. Signal tracing involves using the signal as a basis of measurement, so the signal must be located at some point in the receiver before it is to be traced.

Signal tracing can begin at the antenna. Here the serviceman will hear the signal at the antenna untuned, or perhaps a multitude of signals. Then the probe can travel along through the set from the grid to the plate of each



The Superior CA-11 portable Signal Tracer.

To check the speaker, open one connection between the voice coil of the speaker and the output transformer C, then connect the clip of the test-lead (ground) to the output transformer wire.

Now touch the probe to the other output transformer wire. If a signal is indicated, the voice coil of the speaker is either shorted or open. Touch the probe tip to the speaker wire. No signal means an open voice coil, a signal means a shorted voice coil. If when touching the other end of the output transformer, no signal is heard, the speaker (output) transformer is defective. If no signal is heard at the plate of the output tube B, (the ground clip being connected to the receiver chassis), place the probe tip to the grid D of the output tube. A signal at this point means that the signal is being lost after the grid of the tube. The cause of trouble may be a defective tube, an open cathode resistor (F) or shorted by-pass condenser (E). The by-pass condenser E can be tested by simply disconnecting one lead. If the condenser is shorted, the signal will now be heard in the speaker. To check the cathode resistor, place the probe tip to the cathode of the tube F. A loud signal at this point means an open cathode resistor.

The next point to check is the coupling condenser H. If when touching the probe tip to the plate of the preceding tube G, a signal is heard but none when touching the grid D of the output tube, the condenser is open.

If no signal is heard at point G, advance the probe tip to the grid J. A signal at this point but no signal at G means a defective first audio stage. This tube and its associated parts should be checked in the manner outlined above. L, the coupling condenser between the volume control and the first audio grid J should be tested by first placing the probe tip at the first audio grid J and then at M (the "hot" side of the volume control). A signal at point M but none at J means an open coupling condenser L or a defective volume control.

(Continued on page 510)

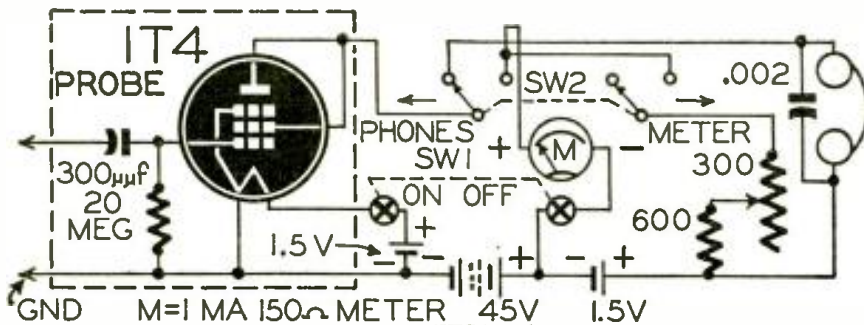

Fig. 1—Circuit of the little signal tracer. Parts shown in dashed lines are in the probe.

mica condenser serves a dual purpose. It acts as a blocking condenser to prevent the application of d.c. to the grid of the tube, and also acts as an attenuator network in combination with the 20-megohm resistor. The resistor also provides the bias voltage for the tube and serves as a grid return.

A VACUUM-TUBE VOLTMETER

The circuit is essentially a vacuum-tube voltmeter designed to function as a signal tracer. It will indicate relative signal intensity directly on the meter.

tube, noting the amplification of that tube; to the grid of the next, and so on through the circuit. When a point is reached where no signal is found, the fault lies between it and the last point checked.

The alternative method is to start with the speaker and trace back to the antenna. Place the detector probe against the plate of the output tube B. If a strong signal is indicated at this point and no signal is heard in the loudspeaker, it may be safely assumed that the speaker is defective.

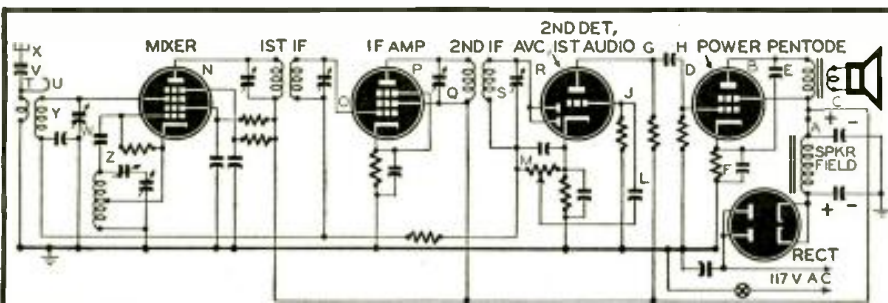

Fig. 2—Typical radio receiver, marked up to show where tracer probe is to be applied.

THE CRYSTAL FILTER

Part II—Putting a Crystal-Filter Set into Operation

BEFORE a receiver's crystal circuit can be used effectively, some preliminary experiments should be made to set it up for crystal operation. The first step is to find the setting of the beat frequency oscillator (b.f.o.) pitch control at which the b.f.o. will be at the peak crystal response frequency. This can be found in either of two ways, whichever works best with the particular receiver used. One method is to turn on the crystal and the b.f.o., and then swing the b.f.o. pitch control rapidly back and forth. This can be heard best when tuned to a frequency where there is no signal. A plop or ping will be heard each time the control passes a certain setting. This noise is caused by the crystal oscillating momentarily, and it indicates when the b.f.o. is at crystal frequency.

The second method is to tune the receiver to some frequency where there is no signal, turn up all the gain, and turn on the crystal and the b.f.o. Since the noise coming through the receiver is restricted to a very narrow band of frequencies, it acts essentially as one signal. Therefore, as the b.f.o. pitch control is rotated, the pitch of the noise will seem to change. The desired setting will be indicated when the noise is brought to zero beat. This procedure should be repeated

several times in order to establish the correct setting as accurately as possible, after which the setting should be noted for future reference.

CHECKING RECEIVER ALIGNMENT

The next step is to determine whether the receiver i.f. system is aligned to the crystal frequency. The crystal is usually ground for the nominal intermediate frequency of the set, but it is entirely possible that the set may have been aligned a few kilocycles off that frequency. This has little or no effect on the i.f. performance of the receiver, but it seriously limits performance when operating with the crystal. To determine the conditions of alignment, first set the b.f.o. pitch control to the setting determined above, then turn the b.f.o. off. With the crystal off, automatic volume control off, and receiver selectivity set sharp, carefully tune in some AM signal. (A broadcast station will do). Then switch the b.f.o. on again and note the pitch of the beat note. This pitch indicates the difference between the intermediate frequency and the crystal frequency. Repeat the procedure several times. If the beat note is consistently more than a thousand cycles or so, realignment is indicated if best crystal operation is to be obtained.

If realignment is desired, it is, of

course, important that it be undertaken only with full knowledge of recommended procedure and adequate equipment. After all, any receiver with a crystal is likely to be a pretty elaborate piece of equipment in the first place. As one suggestion, it might be pointed out that the beat frequency oscillator, set as determined before, provides a convenient reference frequency at which to set the signal generator for i.f. alignment.

PHASING CONTROL SETTING

The third and final preliminary experiment is to find the setting of the phasing control at which the crystal circuit is balanced. Tune the receiver to some frequency at which no signal is received, turn off the b.f.o., and advance all gain controls. If the receiver has a selectivity control, leave it at its broad setting. Turn the crystal on. Since an increase in selectivity permits less noise to come through the receiver, and since greatest selectivity is obtained when the crystal circuit is balanced, the desired setting can be found by simply adjusting the phasing control until the least noise is heard. This setting should be noted.

Once the receiver has been set up for crystal operation, a few minutes of practice with a steady dependable signal will serve to confirm the action of a crystal filter as described earlier and will help in determining the individual peculiarities of the particular receiver involved. Only a thorough familiarity with this circuit will make possible rapid and accurate adjustment under pressure.

Either a press telegraph station or a broadcast station will provide a good continuous signal. If a broadcast station is used, the a.f. gain should be kept maximum and the r.f. gain as low as possible to minimize the amount of modulation that will come through.

When a suitable signal has been selected, turn on the b.f.o. and set its pitch control to the setting determined above, leaving the crystal off for the time being. Tune the desired signal to zero beat, then readjust the b.f.o. pitch control to give the familiar beat whistle. Finally, turn on the crystal circuit and set its phasing control to the balanced position.

This procedure would theoretically bring the signal through at the peak crystal response frequency; but since the crystal selectivity is so sharp and since the adjustments cannot ordinarily be perfect, it will be necessary to tune the receiver a little to bring the signal through.

Carefully tune the receiver only a few hundred cycles each way. The pitch of the beat note will change, of course, but
(Continued on page 497)

RADIO TERM ILLUSTRATED



Suggested by: Ronald R. Rhodes, Englewood, N. J.
"A good resistor"



Mr. Radioman! **CREI Training Can Equip**
You To Step Ahead of Competition
and Gain the Confidence Born of
Knowledge

Will You Be Ready?
CREI Can Prepare You Now for
a Better Job and a Secure Career
in RADIO-ELECTRONICS.



CREI Technical Home Study Training Prepares You for the Secure radio Jobs that pay good money for ability.

You can be ready to enjoy the security of an important engineering position and take advantage of new career opportunities . . . if you prepare yourself now.

Join the ambitious radiomen who are assuring themselves of secure good-paying jobs with a planned program of advancement made possible by CREI home study training in Practical Radio-Electronics Engineering.

You can study at home—in your spare time—develop your technical ability—increase your knowledge to keep pace with important developments now taking place in the industry.

Crei home study courses are constantly being revised and kept up-to-date with the rapid developments in the industry.

By adding CREI training to your present radio experience you can safeguard your future and keep pace with such new developments as U.H.F. Circuits, Cavity Resonators, Pulse Generators, Wave Guides, Klystrons, Magnetrons and other tubes. Are you equipped to handle them? CREI is equipped to help you, by providing the know-how and ability that is required.

In our proved method of instruction, you learn not only how but why! Easy-to-read-and-understand lessons are provided well in advance, and each student has the benefit of personal guidance and supervision from a trained instructor. This is the basis of the CREI method of training for which many thousands of professional radiomen have enrolled since 1927.

Act now. Get under way today! It costs nothing but a moment's time to send for complete details—without obligation.

CAPITOL RADIO Engineering Institute

HOME STUDY COURSES IN PRACTICAL RADIO-ELECTRONICS
 ENGINEERING FOR PROFESSIONAL SELF-IMPROVEMENT

Dept. RC-4, 3224—16th Street, N. W., Washington 10, D. C.

Contractors to U. S. Navy—U. S. Coast Guard—Canadian Broadcasting Corp.
 Producers of Well-trained Technical Radiomen for Industry.

• **WRITE TODAY for FREE BOOKLET** 

"Your Opportunity in the New World of Electronics"

If you have had professional or amateur experience—let us prove to you that we have something you need to qualify for a better radio job. To help us to intelligently answer your inquiry—PLEASE STATE BRIEFLY YOUR BACKGROUND OF EXPERIENCE, EDUCATION AND PRESENT POSITION.

Member: NATIONAL COUNCIL OF TECHNICAL SCHOOLS

WORLD-WIDE STATION LIST

THE Voice of the Andes, HC-JB, in Quito, Ecuador, has completed fourteen years of broadcasting, and is celebrating by adding another transmitter to its equipment. This will be 10,000 watts power and will be used in the 31-meter band. When transmissions were started there in 1934 they covered only the nearby territory, using one transmitter in one language and a staff of three. At the close of 1945 they were using six transmitters requiring a staff of one hundred people, and covering the world with fourteen languages. The number of programs monthly has increased from 30 to 600. They are heard best on 12.5 megacycles, and in the morning on 15.2 mc with 1000 watts power. At night they may be heard on 9.9 and 6.2 mc with 1000 watts each. Ten thousand watts power is used on 12.5 mc.

VLC5 is now heard to eastern North America on 9.54 megacycles at 8 to 8:45 am, to western North America over VLG4 on 11.84 and VLC6 on 9.615 mc, from 11 to 11:45 am, over VLC7 on 11.84 mc and VLG3 on 11.71 mc from

12:10 to 12:45 pm. Other Australian transmissions are as follows:

1:00 to 1:40 am	VLG3	11.84	to Tahiti in French
1:00 to 1:40 am	VLC4	15.315	to Tahiti in French
1:50 to 2:25 am	VLG3	11.84	to Britain in English
1:50 to 2:25 am	VLC4	15.315	to Britain in English
2:30 to 2:55 am	VLG3	11.84	to Japan in Japanese
2:55 to 3:30 am	VLA6	15.2	to Japan in Japanese
2:55 to 3:30 am	VLC2	9.68	to Japan in Japanese
3:10 to 3:55 am	VLG10	11.76	to New Caledonia in French
4:00 to 5:00 am	VLG3	11.71	to the Pacific in English
4:00 to 5:00 am	VLC6	9.615	to the Pacific in English
5:00 to 6:45 am	VLG3	11.71	to Asia in Japanese, Chinese, English, Malay and Dutch
5:00 to 6:45 am	VLC6	9.615	to Asia in Japanese, Chinese, English, Malay and Dutch
7:00 to 7:30 am	VLG4	11.84	to Asia in Malay and English
7:45 to 9:00 am	VLG3	11.71	to Asia in French
7:45 to 9:00 am	VLC6	9.615	to Asia in French
7:45 to 9:00 am	VLA	7.28	to Asia in French

9:00 to 9:30 am	VLC6	9.615	to Asia in English
9:00 to 9:30 am	VLA	7.28	to Asia in English
9:00 to 9:30 am	VLG	9.58	to Asia in English
10:15 to 10:45 am	VLG5	11.88	to Britain in English
10:15 to 10:45 am	VLC8	7.28	to Britain in English
10:15 to 10:45 am	VLA3	9.68	to Britain in English
5:30 to 6:00 pm	VLC4	15.315	to Asia in Japanese

CBFX in Montreal is now being heard on 9.610 megacycles with a power of 7500 watts. It is operated by the Canadian Broadcasting Corporation with studios and offices at 1231 St. Catherine Street, West. Reports sent to them will be acknowledged.

A transmitter in Palestine has been heard on the east coast on 6.135 megacycles. Jerusalem has been reported heard on 6.790. Both of these carry the same program, and have been heard at various hours from 10 p.m. to 1:30 a.m. CNR3 in Rabat, French Morocco, has been heard on 9.095 around 4 p.m.

All schedules are Eastern Standard Time.

Freq.	Station	Location and Schedule	Freq.	Station	Location and Schedule	Freq.	Station	Location and Schedule
2.500	WWV	WASHINGTON, D. C.; U. S. Bureau of Standards, 6 pm to 8 am.	3.400	YV5RW	CARACAS, VENEZUELA; 5:30 am to 10:30 pm.	3.500	COCX	HAYANA, CUBA; heard evenings.
2.880	GRC	LONDON, ENGLAND.	3.420	YV2RC	MERIDA, VENEZUELA; 6 to 9:30 pm.	3.510	YV6RC	BARQUISMETO, VENEZUELA; 6 to 9:30 pm.
3.228	HDZ	RIOBAMBA, ECUADOR; Thursdays, 9 pm.	3.440	YVIRU	MARACAIBO, VENEZUELA; 7 to 9:30 pm.	3.530	YV5RS	CARACAS, VENEZUELA; 5:30 am to 10:30 pm.
3.310	YVIRO	TRUJILLO, VENEZUELA; 5 to 9:30 pm.	3.460	YV4RP	VALENCIA, VENEZUELA; 8 to 9:30 pm.	3.914	ZQP	LUSAKA, RHODESIA; 10:30 am to 1 pm.
3.340	VUD3	DELHI, INDIA; 11 to 11:45 am.	3.480	YV4RQ	PUERTO CABALLO, VENEZUELA; 5 to 9:30 pm.	3.935	HC5EH	CIUDAD CUENCA, ECUADOR; 6 to 10:30 pm.
3.370	YVIRT	MARACAIBO, VENEZUELA; 5:30 to 10:30 pm.	3.490	YV3RS	BARQUISMETO, VENEZUELA; 4:30 to 9:30 pm.	4.040		PONTA DEL GADA, AZORES; 4 to 6 pm.
3.380	YV5RY	CARACAS, VENEZUELA; 9:30 am to 10:30 pm.	3.500	YV5RX	CARACAS, VENEZUELA; 6:30 am to 10:30 pm.	4.105	HCJB	QUITO, ECUADOR; 6 to 10:30 pm.
3.390	YV4RK	MARACAY, VENEZUELA; 6 to 10:30 pm.				4.600	HHCA	PORT-AU-PRINCE, HAITI; 7:30 to 9 am; 5 to 9:30 pm.
						4.750	YVIRV	MARACAIBO, VENEZUELA; 6 to 9:30 pm.
						4.760	YV5RV	LA GUAIRA, VENEZUELA; 5 to 9:30 pm.
						4.770	YVIRY	CORO, VENEZUELA; 4 to 10 pm.
						4.780	YV4RO	VALENCIA, VENEZUELA; 4:30 to 9:30 pm.
						4.785	HJAB	BARRANQUILLA, COLOMBIA; 5 to 10:55 pm.
						4.810	YVIRL	MARACAIBO, VENEZUELA; 6:30 am to 11 pm.
						4.815	HJBB	CUCUTA, COLOMBIA; 5 to 10 pm.
						4.825	HJED	CALI, COLOMBIA; 7 to 11 pm.
						4.840	YVIRZ	VOLERA, VENEZUELA; 4:30 to 9:45 pm.
						4.855	HJCA	BOGOTA, COLOMBIA; 6 to 10 pm.
						4.865		BELEM, BRAZIL; 5 to 7 pm; 8 to 9 pm.
						4.880	HJFH	ARMENIA, COLOMBIA; 6 am to 10 pm.
						4.890	YV5RM	CARACAS, VENEZUELA; 5:30 to 10:30 pm.
						4.895	HJCH	BOGOTA, COLOMBIA; 6 to 10 pm.
						4.920	CR7BO	LOURENCO MARQUES, MOZAMBIQUE; Sundays, 11 am to noon.
						4.920	YV5RN	CARACAS, VENEZUELA; 6 am to 10:30 pm.
						4.925	HJAP	CARTAGENA, COLOMBIA; 6 am to 1 pm; 5 to 10 pm.
						4.945	HJCW	BOGOTA, COLOMBIA; 6:45 am to 11:15 pm; 4 to 6 pm; 7 pm to 11:15 am.
						4.970	VQ5LO	NAIROBI, KENYA; noon to 2 pm.
						4.955	HJCO	BOGOTA, COLOMBIA; 10 am to 2 pm; 5 to 11 pm.
						4.965	HJAE	CARTAGENA, COLOMBIA; 4 to 10:30 pm.
						4.965		ADDIS ABABA, ETHIOPIA; 11:30 am to 12:30 pm.
						4.975	HJAG	BARRANQUILLA, COLOMBIA; 9 am to 11 pm.

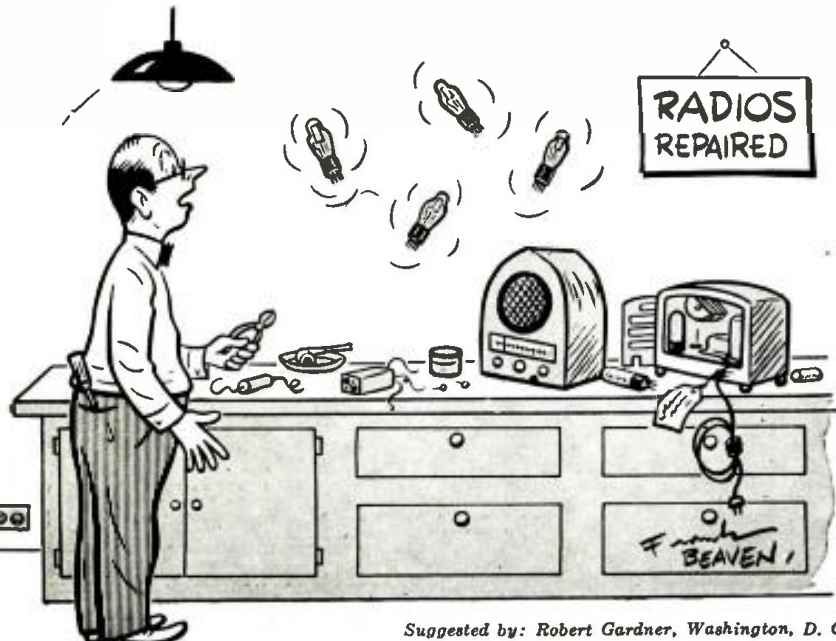

Suggested by: Robert Gardner, Washington, D. C.

"... must be gas filled tubes!"

(Continued on page 511)

Specified

BY AMERICA'S MOST CRITICAL SERVICE ENGINEERS

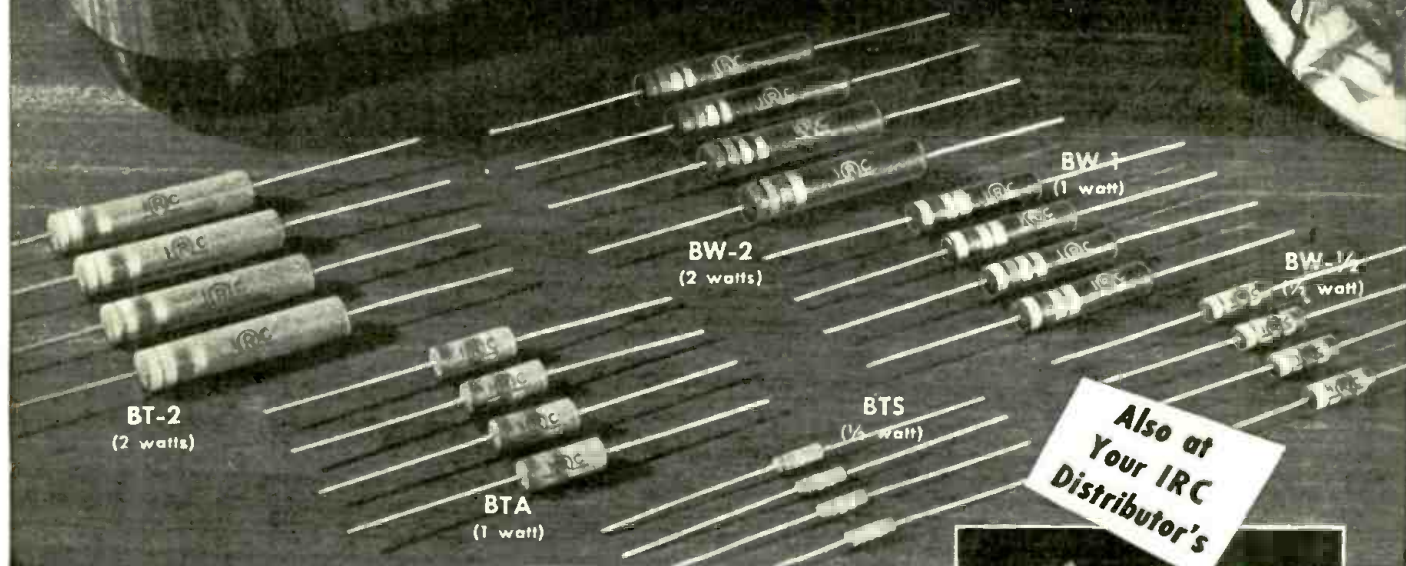

TYPE BT INSULATED Metallized RESISTORS TYPE BW INSULATED Wire Wound RESISTORS

... the perfect combination for speedy, dependable servicing!

Almost any piece of carbon is a "resistor". But a really good resistor, scientifically designed to meet every requirement of exacting radio and other electronic servicing, is something else again. For example, users of the famous Type BT have found that IRC's exclusive Metallized filament-type construction is a far cry from ordinary resistors. Since the beginning of Radio, this unique design principle has made possible far greater stability, more rugged construction and complete dependability in a very compact, low-cost unit.

Now, two new BT types, the BTS and BTA, are available. Designed to meet all the exacting requirements of modern servicing, they are conservatively rated at 1/2 watt and 1 watt, respectively, and incorporate all the excellent characteristics of older, larger types in a much smaller, more convenient size.

For greater stability and all-around efficiency in the lower ranges, the IRC Type BW Insulated Wire Wounds are recommended. A stock of these units and the Type BT in assorted ranges and wattages give you the ideal combination to solve almost any servicing problem... quickly and profitably.

The Resistor You Need . . . When You Need It!

Your local IRC Distributor now has quite complete stocks of BT's and BW's, in standard RMA ranges, ready for you. You'll find him a dependable source (and a very cooperative guy) for all of the IRC products shown on this page. He'll also be glad to give you your copy of IRC Service Catalog #50.

FOR BETTER-THAN-STANDARD QUALITY

Standardize on



INTERNATIONAL RESISTANCE CO.

Dept. 25-D 401 N. Broad Street, Phila. 8, Pa.

Makers of more types of resistance units, in more shapes, for more applications, than any other manufacturer in the world.

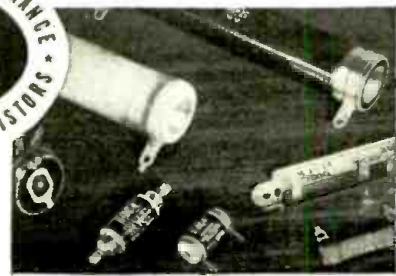
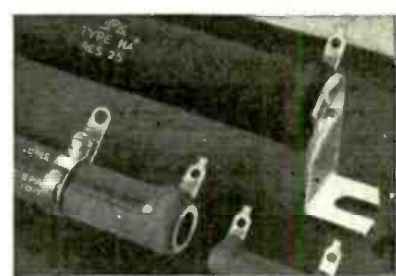

MOST-OFTEN-NEEDED

RADIO DIAGRAMS

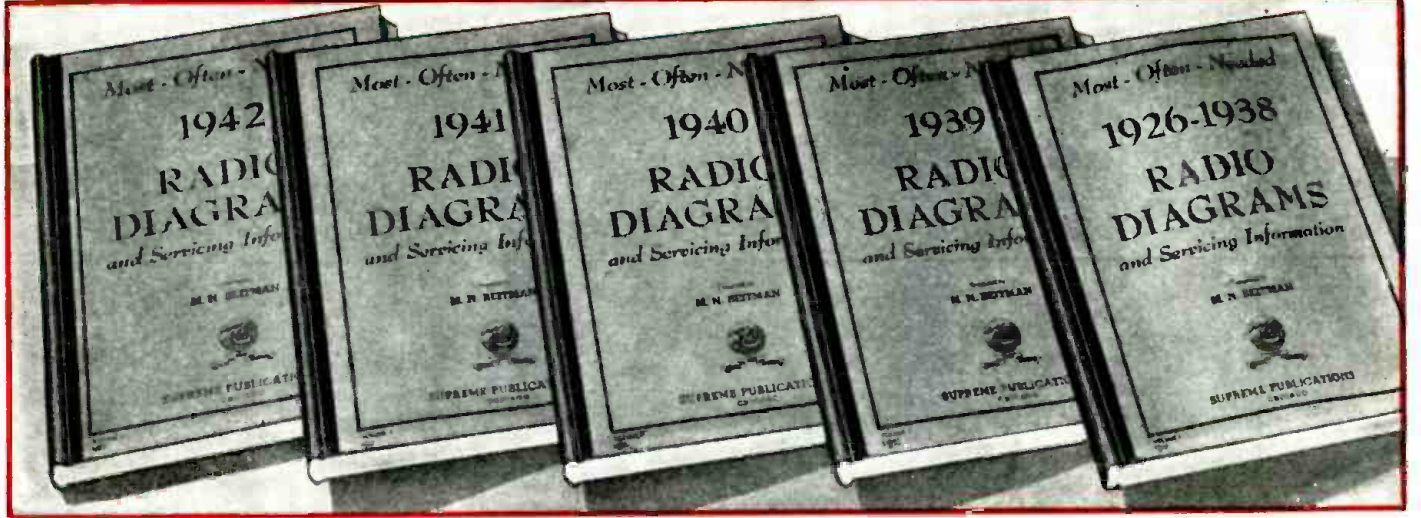

1942 4 Out of 5 Diagrams You Will Ever Need

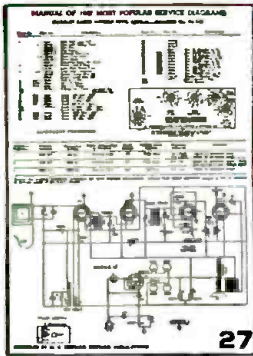

Find radio faults quickly. Make the needed repairs in any radio. Save time on every job. This large, new and inexpensive diagram manual has the circuit for every popular 1942 radio set. 4 out of 5 diagrams you will ever need are included.

WITH ALIGNMENT DATA
Clearly printed circuits, alignment data, parts lists, service hints are the facts you need to speed up all radio servicing. Repair radios quickly and properly—follow the factory instructions given in these manuals. 351 models of 40 largest manufacturers. 192 fact packed pages. Large size. 8½ x 11 in. Manual style binding. Well printed. Price postpaid, only **\$2.00**

NEW, POPULAR, LOW-PRICED MANUALS

1941 These easy-to-apply, inexpensive manuals will help you repair radios faster. This volume covers 1941 models, with alignment data, I.P. peaks, and replacement parts lists. Compiled by M. N. Beitman, radio serviceman for many years, author, and teacher. Be an expert in radio servicing; simplify your work. 192 pages 8½ x 11 inches. Only **\$2.00**

1940 Let this important manual give you over 80% of all 1940 circuits you will ever need, acquaint you with new developments, train you to service quickly and efficiently millions of sets. Data on F.M., portables, recording, etc. 417 models of 43 manufacturers. 208 pages. Net price... **\$2.00**



1939 Another handy manual of the most popular diagrams you need. Circuit data, hints and information are time-savers and money-makers for you. Let these diagram manuals guide you to easier service work. Why try to get along without helpful diagrams? Use this volume with 192 pages of diagrams of 39 makes. Only **\$2.00**

Most Popular Models Made by:
Philco, R.C.A., Zenith, Sears, GE, Emerson, Belmont, Detrola Radio, Fada, United Motors, Westinghouse, Arvin, Majestic, Stewart-Warner, Admiral, Delco, Stromberg-Carlson, Western Auto, Sparton, Motorola, Wards, Gamble, and many others.

Other Practical Radio Manuals

RADIO & ELECTRONICS COURSE
53 LESSONS — 3 VOLUMES IN ONE — LARGE SIZE
New home-study course covers every topic of radio repairing, theory and electronics. Brush-up on radio fundamentals, use the service case-histories, follow the practical hints, get ahead in radio. Volume 1 contains 13 lessons on *Fundamentals of Radio*. Volume 2 has 9 large lessons on *Receivers, Transmitters and Testers*. Volume 3 covers all electronic topics and radio servicing in 31 lessons. All 53 lessons, of course, supplied in one extra large manual, 8½ x 11 in., wt. 3½ lbs. Price complete **\$3.95** for all lessons

- ★ STEWART-WARNER MANUAL 50c
 - ★ ARVIN DIAGRAM MANUAL 50c
 - ★ GENERAL-ELECTRIC MANUAL 50c
- 64 pages of popular circuits. Size: 5½ x 8½ inches

PRACTICAL RADIO MATHEMATICS



Introduces and explains the use of arithmetic and elementary algebra in connection with units, color code, meter scales, Ohm's Law, alternating currents, ohmmeter testing, wattage rating, circuits series and parallel connections, capacity, inductance, mixed circuits, vacuum tubes, curves, the decibel, etc., etc., and has numerous examples. Price, postpaid, only **25c**

See Your Radio Jobber or Send Coupon

Supreme Publications

PUBLISHERS OF RADIO BOOKS, MANUALS, AND DIAGRAMS

1926-1938 The most popular volume of the series. Will pay for itself with the time saved during the first day of use. Includes all the popular old timers. Save hours on every job. 427 diagrams of the most serviced radios of this period, with parts lists and alignment information. 240 pages, 8½ x 11 inches. Sold with a money back guarantee. Price, postpaid, **\$2.50**



Compiled by M. N. Beitman, radio engineer, teacher, author & serviceman.

SAVE HOURS ON EVERY JOB

Be ready to make repairs in minutes instead of hours. You will be called upon to fix hundreds of models listed in these easy-to-use manuals. Tackle each job with the needed help found on every page in these handy service manuals. Greatest bargain in diagram books. Send your order today. Use these manuals this week.

NO RISK TRIAL ORDER COUPON

SUPREME PUBLICATIONS, 9 S. Kedzie Ave., Chicago 12, ILL.

Ship the following manuals: (Money back guaranteed)

- 1942 1941 1940 1939 1926-1938
 Radio & Electronics Course Stewart-Warner Arvin
 General-Electric Manual Radio Mathematics

I am enclosing \$..... send postpaid.

Send C.O.D. I am enclosing \$..... deposit.

Name:

Address:

(Use Coupon or Write Order in a Letter)

LIFE-EXTENSION BY THE GRAM

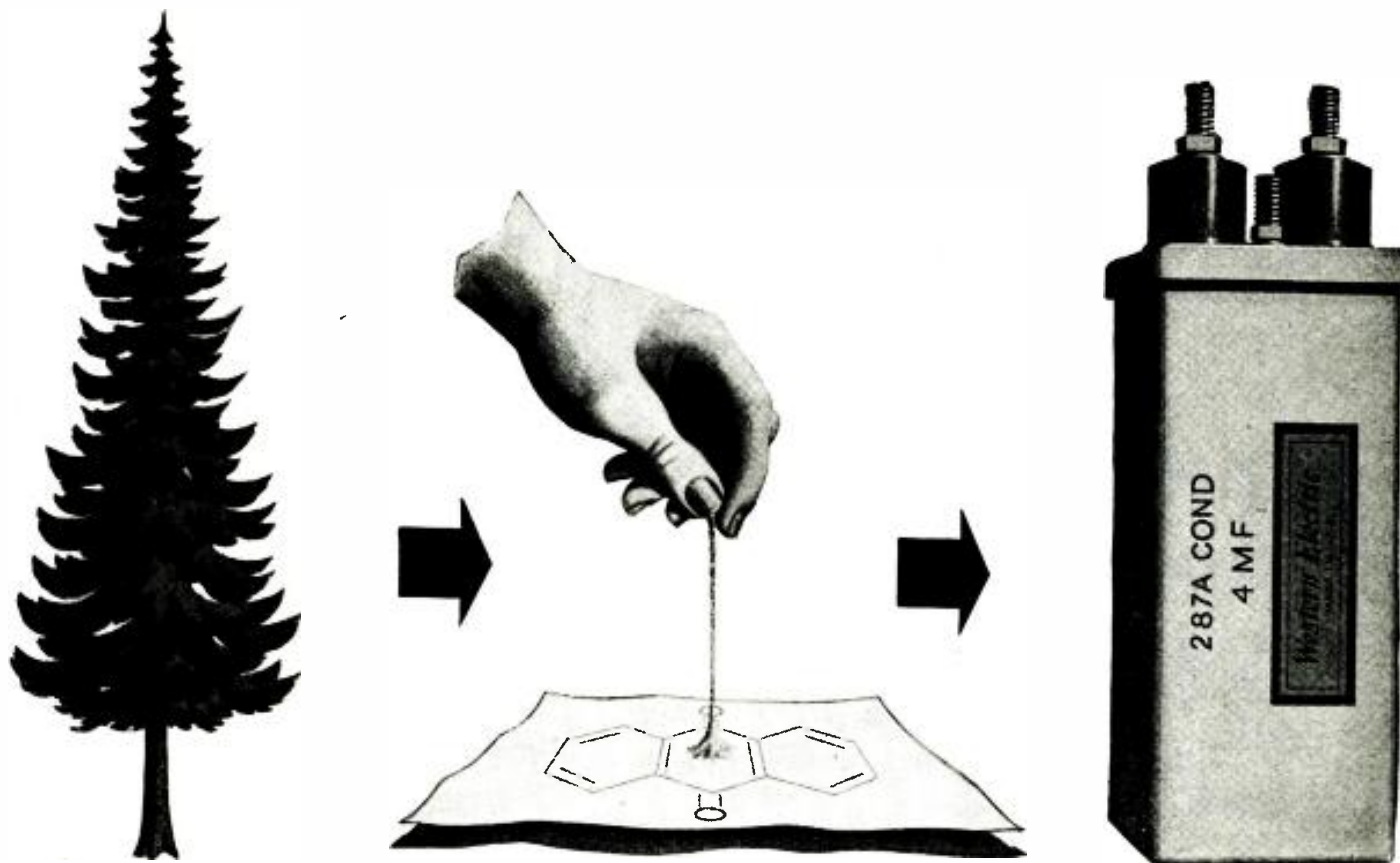

CRUCIAL links in every wire and radio system are paper capacitors — rolls of impregnated paper and metal foil. At least one is in every telephone — and more than 100 million are in the Bell System. A single failure can sever a telephone call, put a costly line out of service. So finding out how to make capacitors stand up longer is one of the big jobs of Bell Telephone Laboratories.

All-linen paper was once the pre-eminent material. Then wood pulp was tried — and found to last longer

under heat and direct voltage. But why? Something in the wood was helping to preserve life. What was it?

Ultra-violet light, delicate micro-chemical analysis and hundreds of electrical tests gave a clue. Researchers followed it up—found the answer by treating the impregnated paper with anthraquinone—a dye intermediate. A mere pinch of the stuff prolongs capacitor life by many precious years.

When war came, great quantities of capacitors were needed for military

equipment, where failures could cost lives, lose battles. The Western Electric Company, manufacturing for the Bell System, willingly disclosed the life-preserving treatment to other manufacturers. Today in communication capacitors, the new "life-extension" is helping to give more dependable telephone service.

Day by day, resources of this great industrial laboratory are being applied to perfect the thousands of components which make up the Bell System.



BELL TELEPHONE LABORATORIES EXPLORING AND INVENTING, DEVISING AND PERFECTING FOR CONTINUED IMPROVEMENTS AND ECONOMIES IN TELEPHONE SERVICE.

PLEASE PLACE YOUR ORDER WITH YOUR REGULAR RADIO PARTS JOBBER. IF YOUR LOCAL JOBBER CANNOT SUPPLY YOU, KINDLY WRITE FOR A LIST OF JOBBERS IN YOUR STATE WHO DO DISTRIBUTE OUR INSTRUMENTS OR SEND YOUR ORDER DIRECTLY TO US.



The New Model CA-11 SIGNAL TRACER

Simple to operate . . . because signal intensity readings are indicated directly on the meter!

Essentially "Signal Tracing" means following the signal in a radio receiver and using the signal itself as a basis of measurement and as a means of locating the cause of trouble. In the CA-11 the Detector Probe is used to follow the signal from the antenna to the speaker — with relative signal intensity readings available on the scale of the meter which is calibrated to permit constant comparison of signal intensity as the probe is moved to follow the signal through the various stages.

Features:

- ★ SIMPLE TO OPERATE — only 1 connecting cable — NO TUNING CONTROLS.
- ★ HIGHLY SENSITIVE — uses an improved Vacuum Tube Voltmeter circuit.
- ★ Tube and resistor-capacity network are built into the Detector Probe.
- ★ COMPLETELY PORTABLE — weighs 5 lbs. and measures 5" x 6" x 7".
- ★ Comparative Signal Intensity readings are indicated directly on the meter as the Detector Probe is moved to follow the Signal from Antenna to Speaker.
- ★ Provision is made for insertion of phones.

The Model CA-11 comes housed in a beautiful hand-rubbed wooden cabinet. Complete with Probe, test leads and instructions.....Net price

\$18⁷⁵

The New Model 450 TUBE TESTER

Specifications:

- Tests all tubes up to 117 Volts including 4, 5, 6, 7, 7L, Octals, Loctals, Bantam Junior, Peanut, Television, Magic Eye, Hearing Aid, Thyratrons, Single Ended, Floating Filament, Mercury Vapor Rectifiers, etc. Also Pilot Lights.
- Tests by the well-established emission method for tube quality, directly read on the scale of the meter.
- Tests shorts and leakages up to 3 Megohms in all tubes.
- Tests individual sections such as diodes, triodes, pentodes, etc., in multi-purpose tubes.
- New type line voltage adjuster.
- NOISE TEST: Tip jacks on front panel for plugging in either phones or external amplifier will detect microphonic tubes or noise due to faulty elements and loose internal connections.
- Works on 90 to 125 Volts 60 Cycles A.C.



SPEEDY OPERATION assured by newly designed rotary selector switch which replaces the usual snap, toggle, or lever action switches.

The model 450 comes complete with all operating instructions. Size 13" x 12" x 6". Net weight 8 lbs. **\$39⁵⁰** Our Net Price.....

The Model PB-210 MULTI-METER

Features:

- ★ SPEEDY!
- ★ PUSH-BUTTON OPERATION!

Measures:

- ★ A.C. Volts
- ★ D.C. Volts
- ★ D.C. Current
- ★ Low Resistance
- ★ High Resistance
- ★ Low Capacity
- ★ High Capacity
- ★ Decibels

Specifications:

- 5 A.C. VOLTAGE RANGES: 0 to 10/50/250/500/1000 Volts
- 5 D.C. VOLTAGE RANGES: 0 to 10/50/250/500/1000 Volts
- 5 OUTPUT METER RANGES: 0 to 10/50/250/500/1000 Volts
- 4 D.C. CURRENT RANGES: 0 to 1/10/100 Ma. 0 to 1 Amp.
- 2 CAPACITY RANGES: .0005 Mfd. to .3 Mfd. .25 Mfd. to 100 Mfd.
- 3 DECIBEL RANGES: —10 to +15; +10 to +35; +30 to +55
- 4 RESISTANCE RANGES: 0 to 2,000/20,000/200,000 Ohms. 0 to 20 Megohms

Model PB-210 comes housed in hand-rubbed oak portable cabinet, complete with cover, self-contained battery, test leads and instructions. Net Price.....

\$35⁷⁵



SUPERIOR INSTRUMENTS CO.

Dept. R 227 FULTON ST., NEW YORK 7, N. Y.

AUDELS REFRIGERATION & AIR CONDITIONING GUIDE \$4

New from Cover to Cover—1280 Pages, Fully Illus. Covering basic principles, servicing, operation & repair of household, commercial & industrial refrigeration & air conditioning. A gold mine of essential important facts for engineers, servicemen, shopmen & users.

AUDELS SHEETMETAL PATTERN LAYOUTS \$4

Developed by Experts for Sheet Metal Workers, Layout Men & Mechanics. A Practical Encyclopedia in 10 Sections, size 7 x 10 x 2—1125 Pages—350 Layouts—1600 Illustrations. 1001 Key Facts. Fully indexed for ready reference in answering your layout problems. Covers all phases of sheet metal work including Pattern Cutting, Pattern Development & Shop Procedure.

AUDELS SHEETMETAL WORKERS HANDY BOOK \$1

Practical inside information. Fundamentals of Sheet Metal Work. 888 Pages. Fully illustrated. 11 sections. Clearly written. Essential & important facts, figures, pointers in everyday language. Ready Reference Index.

AUDELS WELDERS GUIDE \$1

A concise, practical text on operation and maintenance of all welding machines for all mechanics. Over 400 pages, fully illustrated. Covers all methods of electric and acetylene welding including airplane work.

AUDELS ANSWERS ON BLUE PRINT READING \$2

For Mechanics & Builders. Covers all types of blue print reading including ship & airplane. 376 pages, fully illustrated. New, complete.

AUDELS NEW MACHINIST & TOOLMAKERS HANDY BOOK \$4

Covers modern machine shop practice in all its branches. 5 Practical books in 1. New from cover to cover. Tells how to set up & operate lathes, screw and milling machines, shapers, drill presses and all other machine tools. 1600 pages, fully illustrated, 5 x 8 1/2 x 2. Indexed. 5 sections. 1—Modern Machine Shop Practice. 2—Blue Print Reading & How to Draw. 3—Calculations & Mathematics for Machinists. 4—Shop Physics. 5—How to Use the Slide Rule. 60 chapters. Easy to read and understand. A shop companion that answers your questions.

AUDELS MATHEMATICS & CALCULATIONS FOR MECHANICS . \$2

Mathematics for home study or reference. 700 Pages. 550 Illustrations. Practical mathematics from beginning. How to figure correctly. New, easy, correct methods covering a complete review. Illustrated & Indexed.

AUDELS AUTOMOBILE GUIDE \$4

A practical quick ready reference book for auto mechanics, service men, operators & owners. Explains theory, construction and servicing of modern motor cars, trucks, buses & auto type Diesel engines. 1540 pages, fully illustrated. 55 chapters. Indexed. A standard book for mechanics.

AUDELS DIESEL ENGINE MANUAL \$2

A practical, concise treatise with questions and answers on the theory, operation and maintenance of modern diesel engines including General Motors 2 cycle Diesel. 384 pages, fully illustrated, flexible binding, pocket size. All details plainly brought out, this book is of extreme value to engineers, operators & students.

AUDELS SHIPFITTERS HANDY BOOK . \$1

238 pages of information, instruction, pictures & reference charts, together with many short cuts & trouble savers for shipfitters in their work.

AUDELS RADIOMANS GUIDE \$4

A key to the practical understanding of radio including Frequency Modulation, Television, etc. Aircraft & Marine Radio. For radio engineers, servicemen, amateurs. 772 pages, 400 Illustrations & Diagrams. Photos. Review Questions & Answers. Reference Index. Authentic, clear, concise.

AUDELS MECHANICAL DICTIONARY . \$4

950 pages. Over 17,000 new and standard mechanical terms, words, phrases, tables, formulas, helps, hints, short-cuts and practical suggestions. The right word when needed most.

AUDELS HANDY BOOK OF PRACTICAL ELECTRICITY \$4

For maintenance engineers, electricians & all electrical workers. 1440 Pages, 2600 Illustrations. Covers important electrical information in handy form—including Marine Wiring, Radio Principles, Welding. Fully indexed. The key to a practical understanding of electricity.

AUDELS CARPENTERS & BUILDERS GUIDES—4 Vols. \$6

A Practical Illustrated trade assistant on modern construction for carpenters, joiners, builders, mechanics and all woodworkers. 4 vols., 1600 pages. 3700 Illustrations, flexible covers. Each volume pocket size. Sold separately \$1.50 a vol.

AUDELS PLUMBERS & STEAMFITTERS GUIDES—4 Vols. \$6

A Practical Trade Assistant & Ready Reference. Explaining in plain language & by clear illustrations, diagrams, charts, graphs, pictures the principles of modern plumbing practice including Marine Pipe Fitting and Air Conditioning. 4 Vols.—1670 Pages—\$643 Diagrams. Each Vol. Pocket Size. Sold Separately \$1.50 a Vol.

AUDELS WIRING DIAGRAMS \$1

210 Pages, Illustrated. Gives practical facts on wiring of electrical apparatus. It explains clearly in simple language how to wire apparatus for practically all fields of electricity. Each diagram is complete & self-explanatory. A Highly Endorsed Pocket Companion.

AUDELS ELECTRIC DICTIONARY \$2

For Every Worker Who Has To Do With Electricity. Enables you to understand and explain electrical problems. Defines more than 9000 words, terms & phrases in plain, unmistakable language, compiled with accuracy & thoroughness. Alphabetically arranged, reference index.

AUDELS MILLWRIGHTS GUIDE \$4

Practical up-to-date information on Plant Installation, Operation and Maintenance. 1200 pages completely illustrated, fully indexed. 1000 facts at your fingertips in 6 convenient sections with ready reference.

GUETHS MECHANICAL DRAWING . . . \$1

A Concise Drawing Course. 150 pages, 50 plates. A complete instructor & reference work. Gives many helpful hints & suggestions on How to Draw.

AUDELS ELECTRONIC DEVICES \$2

Tells What You Want to Know About Electric Eye. Easily Understood. Covering Photo-electric cells & their applications. Amplifiers, Illumination, frequencies, voltage, photocell, tubes, Ohm's Law, wiring diagrams, etc.

AUDEL, PUBLISHERS, 49 W. 23 St., N.Y.

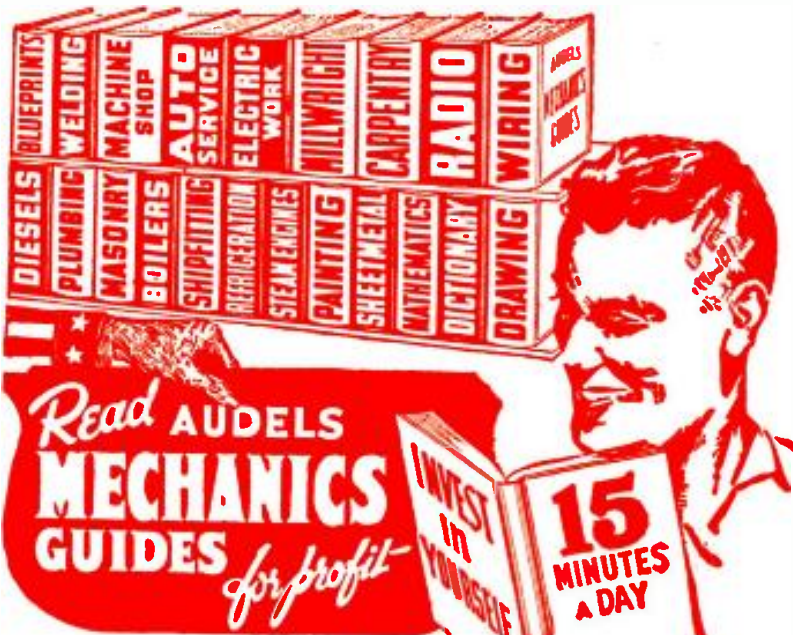

Information in a Handy Form!
AN AUDEL GUIDE IS A GOOD FRIEND!
 Use the brains and experience of others in these Guides of the Trades. Save time and money with right methods, short cuts, labor-saving ideas—"Learn more to earn more." Use our generous 7-day free examination privilege and our dollar a month payment plan. Become a Master in your Trade, and understand the Trades that tie into yours.
 How to obtain these Guides for examination. Mark X on the order blank the Guides desired. Every Audel Guide is complete, up-to-date, easily understood with Questions and Answers, fully illustrated and indexed. They speak for themselves. Send for yours today at our risk and expense. Ask to see them.



Check NOW!

You Can Look Over Any Guide In Your Own Home

Start the Easy Payments If Satisfied

MAIL THIS TODAY

CUT HERE MAIL ORDER

THEO. AUDEL & CO., 49 W. 23 St., New York 10, N.Y.

Please mail me for 7 days' free examination the books marked (X) below. I agree to mail \$1 in 7 days on each book or set ordered, and to further mail \$1 a month on each book or set ordered until I have paid purchase price.

If I am not satisfied with Guides I will return them.

- Audels REFRIGERATION & Air Conditioning Guide . \$4.
- Audels POWER PLANT ENGINEERS GUIDE . 4.
- Audels PUMPS, HYDRAULICS & AIR COMPRESSORS 4.
- Audels WELDERS GUIDE . 1.
- Audels BLUE PRINT READING . 1.
- Audels SHEET METAL WORKERS Handy Book . 2.
- Audels SHEET METAL PATTERN LAYOUTS . 1.
- Audels AIRCRAFT WORKER . 4.
- Audels MATHEMATICS and CALCULATIONS . 1.
- Audels MACHINISTS & TOOLMAKERS Handy Book . 2.
- Audels MECHANICAL Dictionary . 4.
- Audels AUTOMOBILE GUIDE . 4.
- Audels DIESEL ENGINE MANUAL . 4.
- Audels MARINE ENGINEERS Handy Book . 2.
- Audels SHIPFITTERS Handy Book . 4.
- Gueths MECHANICAL DRAWING COURSE . 1.
- Rogers DRAWING and DESIGN . 2.
- Audels MILLWRIGHTS and Mechanics Guide . 4.
- Audels CARPENTERS and Builders Guides (4 vols.) . 6.
- Audels PLUMBERS and Steamfitters Guides (4 vols.) . 6.
- Audels MASONS and Builders Guides (4 vols.) . 6.
- Master PAINTER and DECORATOR . 2.
- Audels GARDENERS & GROWERS GUIDES (4 vols.) . 6.
- Audels ENGINEERS and Mechanics Guides Nos. 1, 2, 3, 4, 5, 6, 7 and 8 complete . 12.
- Audels Answers on Practical ENGINEERING . 1.
- Hawkins Aids to ENGINEERS EXAMINATION . 2.
- Audels ELECTRICIANS EXAMINATIONS . 1.
- Audels WIRING DIAGRAMS . 1.
- Audels Handy Book of PRACTICAL ELECTRICITY . 4.
- Audels ELECTRICAL POWER CALCULATIONS . 2.
- Hawkins ELECTRICAL Guides at \$1. each . 10.
- Audels ELECTRONIC DEVICES . 2.
- Audels ELECTRIC Dictionary . 2.
- Audels RADIOMANS GUIDE . 4.
- Audels NEW ELECTRIC LIBRARY at \$1.50 a Volume Vols. I, II, III, IV, V, VI, VII, VIII, IX, X, XI, XII.

Name _____

Address _____

Occupation _____

Employed by _____ RCF

ONE RADIO PER ROOM?

A NEW concept of the market for home radios is revealed by Frank Mansfield, director of Sales Research, Sylvania Electric Products, Inc. He points out that the number of radio families has generally been considered the key to market saturation. Market studies by Sylvania Electric clearly indicate a tendency toward the increasing use of radios in many different rooms in each radio home. "This trend," says Mansfield, "makes it evident that sales managers should begin to think more of the number of rooms in homes when they are thinking of the market potentials for home radios. If they do, they may find their market saturation points increased two to five times."

The public has not changed its mind to any great extent regarding the type of set it intends to buy, he said, adding that about 38% of the radio listeners still want console combinations; 34% want consoles and 20% want table models. Less than 5% want table combinations, midjets or other types. Emphasizing that this is not a prediction of what the public will buy, he described these figures as "an impartial reflection of what people say they will buy."

About three quarters of the people who intend to purchase radios have already decided how much they will pay for their sets. The trend is markedly toward the larger sets in the higher price ranges. More than 50% say they will pay \$100 or more while less than 10% say they plan purchases of less than \$50. These price ranges cannot be taken as an indication of actual prices but that they were the prices the public now has in mind.

It is necessary to be cautious, as experience with other surveys has shown that many things may happen to change peoples' minds or their buying ability. Properly and conservatively interpreted, however, these surveys may have considerable value.

Slightly more than half of the new sets will be sold to replace old sets while about 40% will represent additional sets for use in some other part of the home. This trend seems to indicate that the sale of home radios has not even begun to reach the saturation point, according to Mr. Mansfield, who pointed out that a surprisingly large number of radios are used in other locations than the living room. Today the living room accounts for 56%; bedrooms 21%; kitchen and pantry 12%; and all other locations about 11%.

Nearly 60% of all new radios will probably be sold through radio, department and furniture stores and sales will follow the prewar pattern rather closely. About 82.3% of those who plan to buy a new set for replacement plan to trade in the old one. About a third of them say their purchase will depend on a good trade-in allowance. Only three out of ten have decided what brand they will buy. The public says it wants 80% of the postwar automobiles equipped with radio.

NEW and **ALLIED'S 1946**
Ready for you! **CATALOG**
of Radio and Electronic Supplies



FREE
Send for it Now!

LARGEST AND MOST COMPLETE STOCKS

Today's handiest, most complete *Buying Guide!* Brings you latest, finest values in parts, tubes, kits, tools, books, test instruments, communications receivers, Ham gear, public address and other equipment. Places at your finger tips over 10,000 items of nationally known guaranteed quality. Makes available to you the world's largest and most complete stocks under one roof . . . ready for rush delivery. Enables you to get everything you need in radio and electronics from one dependable, central source. Send for this new 1946 Catalog now. Save time, work and money!



NEW RADIO SETS

Parade of new 1946 models, including phonoradios, and latest communications receivers covering broadcast, short-wave and amateur bands. Beautiful styles! Wonderful performance! Outstanding values!



HANDY RADIO BOOKS

Specialty prepared by Technical experts for radio training and for helpful reference.

Radio Formulas & Data, Dictionary of Radio Terms, Radio Circuit Handbook, Radio Builders' Handbook, Simplified Radio Servicing, Radio Data Handbook — Six Books No. 37-799, 75c.



OVER 10,000 ITEMS

Biggest section of quality parts and equipment for engineers, dealers, servicemen, soundmen, amateurs, builders. All leading makes, at lowest prices. Send for Free Catalog now.



NEW P.A. EQUIPMENT

Sound systems for every public address requirement. Complete listing of amplifiers, speakers, microphones, accessories. Newest developments with many exclusive features.

ALLIED RADIO CORP.
833 W. Jackson Blvd., Dept. 2-DD-6
Chicago 7, Illinois

Date

- Send FREE New 1946 Catalog.
 Send Six Books No. 37-799 (75c enclosed)

Name

Address

City Zone State

ALLIED RADIO

Everything in Radio and Electronics

TRY THIS ONE

COMPENSATED TONE CONTROL

The volume of my phonograph amplifier dropped as the tone control was adjusted for greater attenuation of the "highs." In the hookup, as shown in "a" it will be noted that the two controls are in parallel with each other. Since this position is especially effective (for removing needle scratch and other reasons) I did not want to change it, and devised the compensating circuit shown in "b."

Now, when I increase the "high" attenuation with the tone control, it auto-

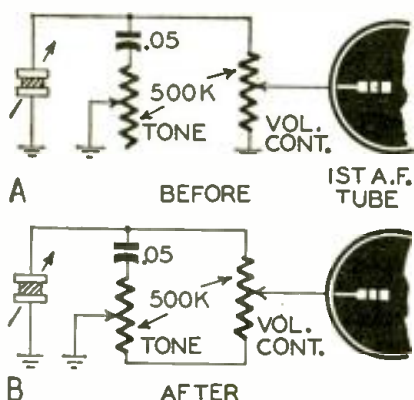

matically increases the amount of resistance between the center arm of the volume control and ground, in effect turning up the volume control and increasing the voltage input to the first tube of the audio amplifier. The ordinary volume control adjustment sets the general volume level, of course.

Values of the circuit were as shown in the diagram. It is possible that a special job with resistance and capacity values chosen for an exact balance might give more perfect compensation, but those given worked very well.

ROY G. LOUGHARY, R.T. 1/c,
Stanfield, Oregon

HEADPHONE ADAPTION

For humless headphone reception from an a.c. radio, try connecting the phones in the power tube input circuit instead of the output. Quality will be

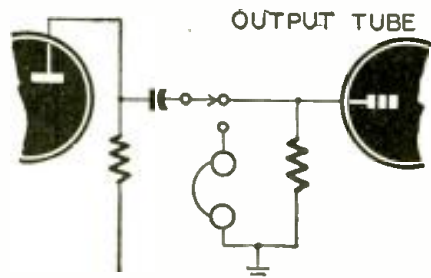

better and volume loud enough for all practical purposes.

In some cases it may be found even better to go back to the first audio tube grid circuit, and headphones can be

PLAGIARISM

Copying articles, excerpts of articles, radio diagrams, etc., for publishing purposes is unlawful. When submitting articles to RADIO-CRAFT, authors are cautioned against copying material which has been published elsewhere.

All publishers protect themselves by Federal Copyright Law. Infringers of this law make themselves personally liable in very expensive copyright law suits.

In submitting material to this, or any magazine, be sure that your contribution is original in all respects.

hooked into the phono input circuits of some radios.

A switch should be connected as shown in the drawing. A single s.p.d.t. will both connect the phones and cut out following stages, silencing the speaker.

PETER BEDROSIAN,
Newburyport, Mass.

SIMPLE TEST OSCILLATOR

An old broadcast coil and condenser, an ordinary high-frequency buzzer and a battery and switch make a very practical test oscillator or signal generator for hunting trouble in sets, and even for alignment.

This type of generator was called a wavemeter in the old days, and though modern servicemen may find it a trifle broad for alignment, it used to be con-

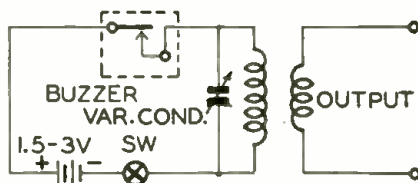

sidered good enough for frequency calibration purposes. Sparking at the buzzer contacts produces a damped-wave signal which is tuned by the secondary of the coil and the variable condenser across it. The primary is used as an output coil. By using an i.f. transformer instead of a broadcast coil, intermediate frequencies can be produced.

One advantage of the broad tuning of this circuit is that it will put a signal through sets so badly misaligned that an ordinary signal generator cannot get through.

HAROLD FREEMAN,
Shreveport, Louisiana

DIAL CORD REPAIR

It often becomes necessary to repair dial cords on late model radios. When these cords break, the common practice is to tie them together. When they just "break down"—that is, when they fail to turn the dial drum or pointer, the

serviceman usually applies a bit of rosin solution or something similar. A solution is not always handy nor is it always effective. Probably the simplest method of repair in such cases is to apply a strip of Scotch tape under the cord. Even a short strip will increase the diameter of the pulley enough to stop the slipping in the most severe cases.

RICHARD R. KENYON,
Middletown, Ohio

EXPERIMENTAL COIL FORM

When changing coils in experimental receiving sets, use an above-chassis socket and to each terminal solder a Fahnestock spring clip. Standard coils can still be plugged in if desired without interfering with the clips and temporary-permanent connections can be made if desired.

When constructing a new coil, if the exact number of turns is not determined, simply wind about half a dozen more turns than you think are necessary to do a required job, attach the free end of the wire or wires to the Fahnestock clip, and then begin taking off turns, making a temporary connection after each turn until the desired number of turns is reached.

This idea can also be used on tube sockets when experimenting with a new type of circuit and where many temporary experimental connections have to be made. A good deal of superfluous soldering can be avoided in this manner.

JOSEPH CZABAN,
Bloomsbury, Alberta

B.F.O. TRANSFORMERS

Very good transformers for beat frequency oscillators can be made from burned-out i.f. transformers.

Cut off the burned-out winding, leaving the good one. (It rarely happens that both windings on one transformer go bad.) Unwind 30-40 turns and take off a cathode tap, then wind them back on again. Attach one of the trimmers across the whole coil and the other between the cathode tap and ground end. The grid leak and condenser can be

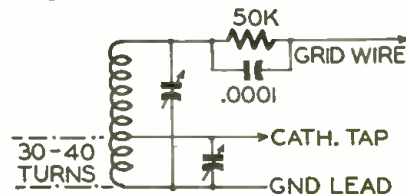

installed inside the shield can, and you have a complete b.f.o. assembly, as shown in the figure.

I have made three of these and had good results with all of them.

D. K. VANDERWATER,
Belleville, Ontario

NOW—A RADIO PEN

(Continued from page 463)

is resistance coupled and untuned. Thus, though each station tuned in has a different i.f., all are amplified equally well. The combination of short antenna and high-Q tuning coil (L1) gives ample selectivity for the purposes of this receiver.

Operation of V3 is interesting. Working first as i.f. amplifier, it rectifies the i.f. signal on its suppressor grid (U. S. Patent No. 2,346,545). The rectified signal is again applied to the grid through RFC-2 and amplified at audio frequency. Automatic volume control is also furnished by the diode section of this circuit.

As Patent restrictions still exist on some of the tubes and circuit features of this receiver, further information, circuit constants, etc., cannot be divulged at present. Enough has been said, however, to make it clear that this is a remarkable receiver circuit.

You will observe that the miniature vacuum tubes had to be specially engineered to meet the electronic requirements explained above. With the present advance of vacuum tube building there was not a great deal of difficulty in solving the various tube problems. Indeed future developments will probably make it possible that an equally excellent set can be evolved with only two tubes instead of the four shown here.

In the present model, the set is sufficiently sensitive to bring in with satisfactory volume all local stations and some distant ones, even if the Radio Pen is used inside a steel-frame building. The set performs similar to any four-tube superheterodyne under similar conditions.

One of the first pens to come off the assembly lines is photographed and shown in these pages. The case is in black plastic, as is the earpiece. Soon other models will be made in a variety of colors to match any color scheme demanded by the eventual user. Other models will be made in metal such as sterling silver and 14-karat gold. The latter are not anticipated to be produced until fall.

The original price for the Radio Pen (for the lowest priced model) was set at \$15.00, but the O.P.A. has not as yet approved this price, nor any of the higher-priced types. There is no question that there will be a very insistent demand for the new Radio Pens once they are manufactured in sufficient quantities.

Needless to say, I am extremely proud of this development, in which I played such a prominent part.

* * * * *

After I had written the above and thought back of the long sleepless nights which I had spent in developing the Radio Pen, I thought—as who would not—that I was entitled to a few weeks well-earned rest. Accordingly, I was
(Continued on page 492)

Announcing 2 NEW CONCORD RADIO CATALOGS

Ready Soon! The presses are roaring now, pouring out the thrill-packed pages of the first great, post-war COMPLETE CONCORD Catalog—featuring

- RADIO SETS**
- AMPLIFIERS**
- RADIO PARTS**
- Electronic Equipment**



Soon it will be in your hands, presenting the complete line of brand new postwar-designed CONCORD Radio Receiving Sets and Amplifiers—incorporating a host of new improvements, new developments, modern cabinets, and superb quality throughout—plus page after page of nationally-known standard, top-quality radio and electronic equipment, supplies and amateur equipment. Mail the coupon below NOW—to be sure your FREE copy will be mailed to you as soon as off the press.



Ready Now! New CONCORD Bargain Book of RADIO PARTS SUPPLIES • EQUIPMENT

Just off the press! The newest, latest Concord Bargain Book listing hundreds and hundreds of money-saving bargains on hard-to-get, standard-make radio parts and electronic equipment. Select your needs from the remarkable values offered in Condensers, Resistors, Meters, Transformers, Volume Controls, Relays, Switches, Generators, Microphones, Speakers, Tools, and hundreds of other items. Mail the coupon for your copy now.

CONCORD

RADIO CORPORATION
LAFAYETTE RADIO CORP.

CHICAGO 7 ★ ATLANTA 3
901 JACKSON BLVD 265 PEACHTREE ST.

Concord Radio Corporation Dept. RC-46
901 W. Jackson Blvd.
Chicago 7, Illinois
Please mail immediately FREE copy of the New
Radio Parts Bargain Supplement—and place my
name on the list to be one of the first to receive
the new CONCORD COMPLETE CATALOG.

Name.....
Address.....
City..... State.....

NEW

... and Individually Marked

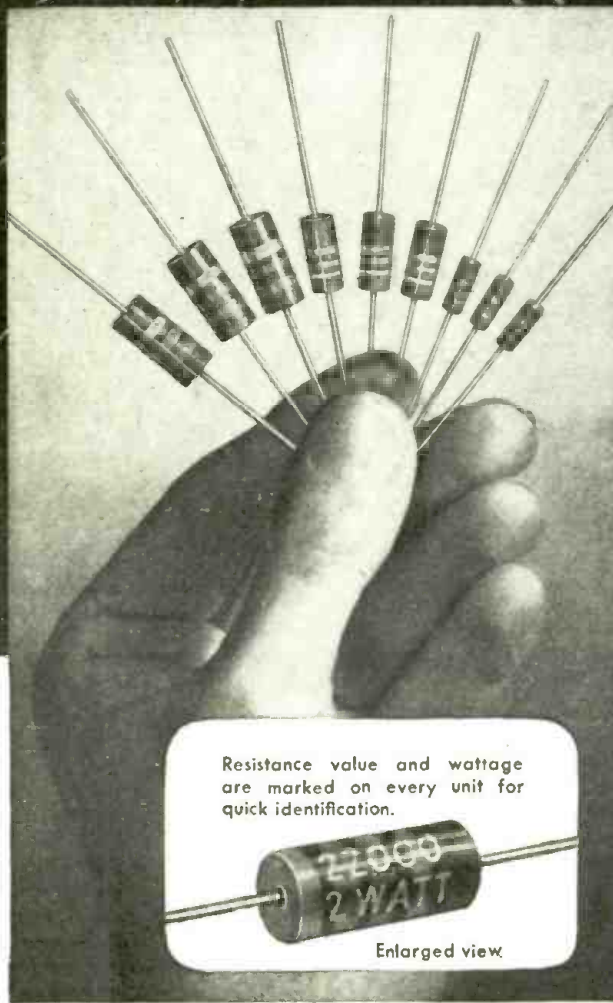

Resistance value and wattage are marked on every unit for quick identification.

Enlarged view

Meet Joint Army-Navy Specification JAN-R-11
AVAILABLE FROM STOCK IN STANDARD
RMA 10% TOLERANCE VALUES

TYPE	SIZE		RESISTANCE RANGE	MAXIMUM VOLTS	LIST PRICE
	LENGTH	DIAM.			
1/2 Watt	3/8"	9/64"	10 Ohms to 22 Meg.	500	13c
1 Watt	9/16"	7/32"	10 Ohms to 22 Meg.	1000	17c
2 Watt	1 1/16"	5/16"	10 Ohms to 22 Meg.	3500	25c



Send Now for
BULLETIN No. 127

Gives complete data and list of RMA values. Includes dimensional drawings and handy color code. Write for it today!

OHMITE

Little Devil

INSULATED COMPOSITION RESISTORS

1/2 Watt • 1 Watt • 2 Watt • ±10% Tolerance

NOW . . . OHMITE makes available to you three *Little Devils* of exceptional ruggedness and stability!

Millions of these tiny molded fixed composition resistors have been used in critical war equipment and in the nation's foremost laboratories. They meet Joint Army-Navy Specification JAN-R-11, including salt water immersion cycling and high humidity tests. They can be used at their full wattage ratings at 70°C (158°F) ambient temperature. They dissipate heat rapidly—have low noise level and low voltage coefficient.

Ratings for maximum continuous RMS voltage drop are high: 500 volts for the 1/2 watt unit—1000 volts for the 1 watt unit—3500 volts for the 2 watt unit. Units have high insulation breakdown voltage.

Little Devils are completely sealed and insulated by their molded plastic construction. Leads are soft copper wire, hardened immediately adjacent to resistor body—strongly anchored—and hot solder coated.

Light, compact, easy to install. All units color coded. Resistance value and wattage are marked on every unit for quick identification. Available from stock in Standard RMA values from 10 ohms to 22 megohms.

Little Devils are ready for any job . . . anywhere. And they're low in cost. Order them now!

Authorized Distributors Everywhere

OHMITE MANUFACTURING COMPANY

4895 FLOURNOY STREET, CHICAGO 44, U.S.A.

Be Right with

OHMITE

RHEOSTATS • RESISTORS • TAP SWITCHES • CHOKES • ATTENUATORS

Where Will You be
in **ELECTRONICS**
IN
1947?

**Study NOW for a
Better Job Then!**

THIS NEW WORLD OF ELECTRONICS is moving at a rapid pace. War born developments equivalent to twenty years of research are here. Still newer techniques are coming out with surprising speed. Have you the basic technical knowledge to keep pace with these developments?

MORE THAN EVER BEFORE, a sound basic knowledge of up-to-date, fundamental engineering of radio-electronics is an essential to a better job—promotion—*increase in pay.*

THESE NEW TECHNIQUES MEAN BRAND NEW JOBS in brand new fields; but they demand men who have knowledge and training—men who know the WHY as well as the HOW. Regardless of your past practical experience, the future demands that you must acquire a solid foundation of theory if you expect to forge ahead in this new world of electronics.

IT COSTS YOU NOTHING TO INVESTIGATE—The coupon on a postcard will bring full information of the CIRE plan of personalized aids and coaching service, with qualified competent instructors, and systematic, progressively arranged study assignments in recognized, approved texts—these are only a few of the many superior advantages of CIRE's plan of spare-time home study training for professional self-improvement.

CIRE HOME STUDY COURSES COVER THE FIELD OF RADIO-ELECTRONICS—TELEVISION, ULTRA-HIGH FREQUENCY TECHNIQUES, AM AND FM BROADCASTING, COMMUNICATIONS ENGINEERING—from simple treatment of fundamentals, through preparation for FCC commercial radio operators' license examinations, up to and including complete high level quantitative treatment of advanced radio-electronics and communications engineering. Choose the course best suited to your needs, and start with the section you are qualified to enter. You pay for only the section or sections you need. Use the "Pay-as-you-go plan" patterned after ethical, educational practice. These features are unique with Cleveland Institute, and represent the best in the modern, post-war concept of home study training.

Many CIRE students of advanced engineering courses today are broadcast chief engineers. Graduates of CIRE courses are eligible for the top jobs in radio-electronics.



Write today for free, descriptive booklet. "THIS NEW WORLD OF ELECTRONICS HOLDS OPPORTUNITY FOR YOU." No obligation—no salesmen.

CLEVELAND INSTITUTE of RADIO ELECTRONICS

Contractors to the Canadian Broadcasting Corporation.

Successors to

NILSON RADIO SCHOOL, Founded 1939

SMITH PRACTICAL RADIO INSTITUTE, Founded 1934

RC-4 TERMINAL TOWER - - - - CLEVELAND 13, OHIO

MAIL THIS COUPON

CLEVELAND INSTITUTE of RADIO ELECTRONICS

RC-4 Terminal Tower, Cleveland 13, Ohio

Gentlemen: Please send information about your home study courses in Radio-Electronics.

NAME

ADDRESS

CITY

ZONE STATE

I desire training in

I have had experience in broadcasting
 servicing operating
 mfg. CAA Army-Navy
 amateur other

I am a High School Grad
 College Grad

I hold a degree in

RACKETEERING REPAIRMEN

HERE in the middle west many radio shops made a racket out of selling and repairing during the war. While it is difficult indeed to get direct evidence, the following dope picked up from serviceman gossip, sets brought in by out-of-towners and aircraft workers and conversations with several wholesalers represents conditions pretty much as they were. A serviceman learns the history of the radio and its repairs from its owner, and many sets brought in told their own tale.

Down in Oklahoma, sets were constructed during the early part of the war to retail at \$45 to \$60. They consisted of a 7B8, 7A7, 7E6, with 7A7 "power output" and a 7F7 rectifier. They were made with very cheap parts and looked as if Junior had thrown them together after school. They would pick up locals for a while.

Radios using three 6SH7's and a 6C5 (a 6SH7 used as r.f., detector and output) came from New York City. Another model used a 6A8, three 6SH7's (i.f. output and rectifier) and a 6SQ7. The TRF was a better radio than the superhet. These retailed for \$32.50 and \$45.00.

Servicing rackets and "junky repairs" equalled the racketeering in "new" receivers.

When the 1-12-25-35-50-70 and 117 series tubes got so hard to get, they could be ordered from New York at \$3.00 each, providing the order was for one hundred or more tubes. The service shops got a "voltage and circuit check" listed at \$3.50 approved by the OPA and added \$1.50 for alignment and the cost of the tube. What was done when two or more tubes had to be replaced is not known.

Another disgusting thing was the shops who advertised "We make any radio play regardless of parts shortage". They substituted 12J5 for 35Z5 and 7N7 for 25Z5 or 25Z6, knowing they couldn't hold up. A 12SK7 or 7B7 and an adaptor replaced a 12SA7. Yes, it worked, local stations would come in on a darn good radio! It worked better if the set had an r.f. stage to drive the tube. I have seen sets using 12SK7 for 35L6 (50L6).

We tested the 12SL7 as a rectifier (both sections tied together) with both a choke and resistance filter. It would put out about 30 volts at the rated current drain of a 5-tube set.

Getting rid of old sets brings up more rackets. One was to take the older two volt sets and put a 6C5 rectifier and two dry cells in them, then sell them for electric sets. Another way to get rid of the old battery sets was to install them in consoles, making a simple 4-tube a.c.-d.c. set on the old chassis, using dummy tubes in the other sockets.

Still another way to get rid of battery receivers was to put a dummy cord on them, clip all the battery cables off, fill them up with burned-out tubes and then sell them at auction. Old electric sets beyond repair were treated the same way.

—W. G. ESLICK

SILVER

"VOMAX"

Of construction and quality unmatched by meters selling at far higher prices . . . giving performance exceeding that of three separate instruments costing nearly four times its price . . . it is no wonder we are told that "VOMAX" is today the standard of comparison.

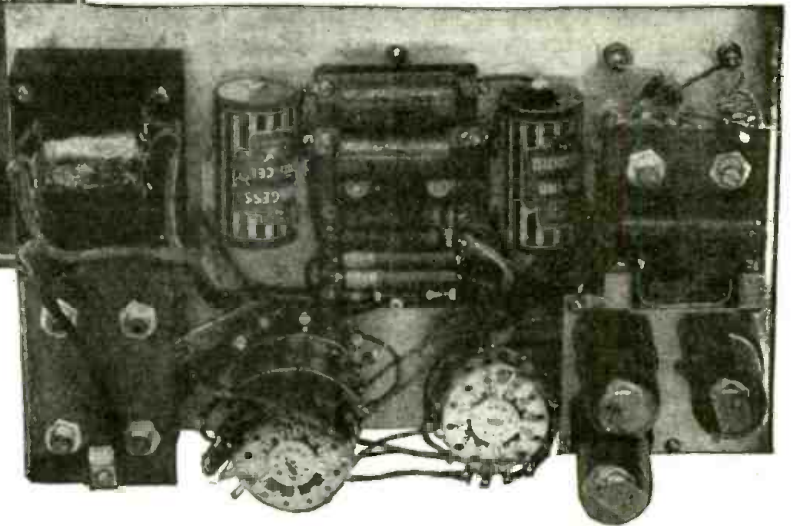
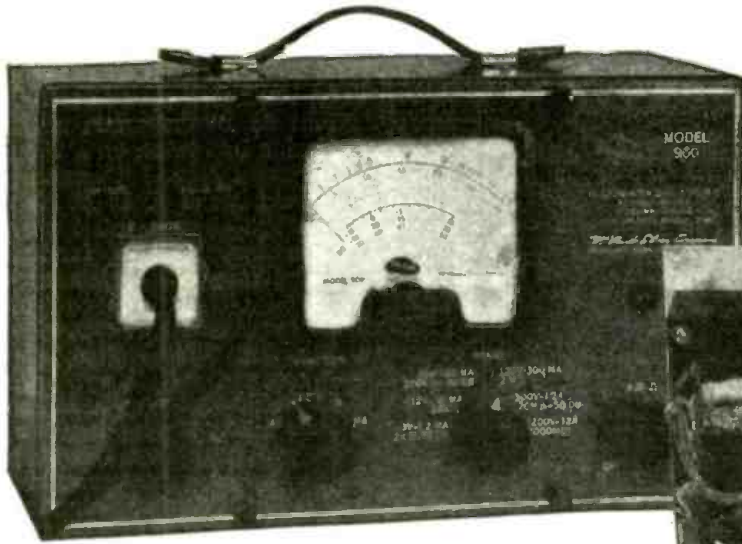

"VOMAX" is new . . . different . . . and outstandingly superior . . . because it is a brand new post-war v.t.v.m. . . . and truly universal. With "VOMAX" you can measure every voltage required in radio servicing . . . even in the design laboratory. Not only does it enable you to measure d.c. and a.c. voltage at meter resistance so high as not to affect the circuit being measured, but "VOMAX" at last lets you measure a.f. and r.f. voltages from 20 cycles to over 100 megacycles . . . resistance from 2 ohms through 2,000 megohms is "duck soup" with "VOMAX" . . . as is direct current from 50 microamperes through 12 amperes.

Add to all this new visual dynamic signal tracing . . . direct measurement of every voltage from receiver antenna to speaker voice coil . . . and you know why many government departments, serious industrial, radio engineering, university research laboratories . . . and service technicians by the thousands clamor for "VOMAX".

"VOMAX" makes you the master, no longer the victim, of tough service problems. Your favorite jobber . . . among nearly 500 progressive SILVER distributors all over the country . . . can give you prompt delivery from his regular monthly allotment . . . if you order now . . . for only

\$59.85 net

ADVANCE ANNOUNCEMENT—Model 904 Capacitance-Resistance Bridge will go into production in April. With $\pm 3\%$ accuracy over the tremendous range of a fraction of one mmfd/ohms through One Thousand mfd/megohms. Model 904 at last gives the serious service technician laboratory accuracy and range—in the new, post-war instrument matching "VOMAX" for only \$49.90.

Measures EVERY Voltage

1. Brand new post war design . . . positively not a "warmed over" pre-war model.
2. More than an "electronic" voltmeter, VOMAX is a true vacuum tube voltmeter in every voltage resistance db. function.
3. Complete visual signal tracing from 20 cycles through over 100 megacycles by withdrawable r.f. diode probe.
4. 3 through 1200 volts d.c. full scale in 6 ranges at 51 and in 6 added ranges to 3000 volts at 126 megohms input resistance. Plus-minus polarity reversing switch.
5. 3 through 1200 volts a.c. full scale in 6 ranges at honest effective circuit loading of 6.6 megohms and 8 mmfd.
6. 0.2 through 2000 megohms in six easily read ranges.
7. 10 through ± 50 db. (0 db. = 1 mw. in 600 ohms) in 3 ranges.
8. 1.9 ma through 12 amperes full scale in 6 d.c. ranges.
9. Absolutely stable—one zero adjustment sets all ranges. No probe shorting to set a meaningless zero which shifts as soon as probes are separated. Grid current errors completely eliminated.
10. Honest factual accuracy $\pm 3\%$ on d.c., $\pm 5\%$ on a.c.; 20us through 100 megacycles, $\pm 2\%$ of full scale, $\pm 1\%$ of indicated resistance value.
11. Only five color-differentiated scales on 4" D'Arsonval meter for 51 ranges (including d.c. volts polarity reversal) eliminate confusion.
12. Meter 100% protected against overload burnout on volts ohms db.
13. Substantial leather carrying handle. Size only 12" x 7" x 5".

Send postcard for free catalog of measurement and communication equipment.

Over 35 Years of RADIO ENGINEERING ACHIEVEMENT

McMurdo Silver Company

1240 MAIN STREET, HARTFORD 3, CONNECTICUT

RADIO-CRAFT for APRIL, 1946



MAKES 90 OUT OF 100 RADIO TROUBLES Easy to Repair!

Complete, Easy Instructions for Repairing Common Troubles in Practically Every Model and Make of Radio in Use Today

Eliminates Needless Testing — Enables You to Repair Two Radios in the Time Ordinarily Required for One

PAYS FOR ITSELF ON THE FIRST JOB!

TELLS WHAT TO DO • EXACTLY HOW TO DO IT

As valuable to a radio repair man as a recipe book is to a cook!

\$5

Ghirardi's RADIO TROUBLESHOOTER'S HANDBOOK (above) is the ideal book to have on hand for training new helpers, repairing either cheap or expensive sets quickly and profitably, eliminating needless test time and equipment—and MAKING MORE MONEY.

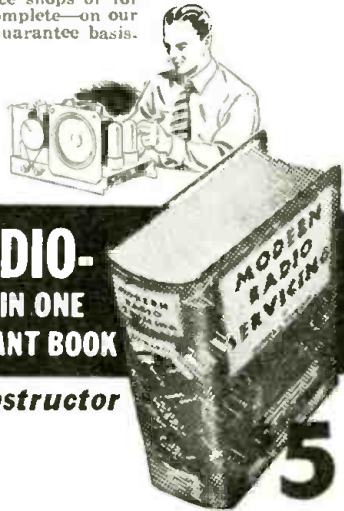

ALL THE SCIENCE OF RADIO-ELECTRONIC SERVICING IN ONE GIANT BOOK

LEARN AT HOME...without an Instructor

Alfred A. Ghirardi's MODERN RADIO SERVICING gives you a COMPLETE, MODERN EDUCATION in truly Professional radio-electronic service methods of the kind that will be your "Open, sesame!" to the big-money opportunities that only well-trained servicemen are in a position to grasp. It is a complete, scientific servicing course from A to Z. You'll be surprised how easily understandable it makes every phase of the work even if you have had no previous service training. And, if you are already in the business, you'll be pleased to learn how this big 1300-page book will serve as a "refresher" course. Not only will it help you handle repair jobs quicker, better and more profitably, but it also will give you the necessary basic training to equip you for profitable industrial electronic work. Specifically written and designed for home study. 1300 pages: 706 clear illustrations. 720 Self-Test Review Questions make it easy for you to check your progress every step of the way. Fully indexed. Only \$5 on our famous 5-Day Money-Back Guarantee.

ENDORSED BY EXPERTS EVERYWHERE

From beginning to end, MODERN RADIO SERVICING brings you the kind of modern professional "Know How" that will pay big dividends for years to come. Gives complete data on test instruments and their use, preliminary trouble checks, scientific circuit analysis and trouble-shooting, parts repair and substitution, how to start and operate a successful service business and hundreds of other subjects.

MONEY-BACK GUARANTEE

MURRAY HILL BOOKS, Inc., Dept. RC-46, 232 Madison Ave., New York 16, N. Y.

Enclosed find \$..... for books checked; or send C.O.D. (U.S.A. only) for this amount plus postage. I may return the books for refund within 5 days if not fully satisfied.

RADIO TROUBLESHOOTER'S HANDBOOK \$5 (\$5.50 foreign)

MODERN RADIO SERVICING \$5 (\$5.50 foreign)

MONEY-SAVING COMBINATION OFFER: Both of the above big books, only \$9.50 (\$10.50 foreign)

Name

Address

City & Dist. No. State

SPECIAL OFFER!

Let RADIO TROUBLESHOOTER'S HANDBOOK save you time on common radio service jobs! Let MODERN RADIO SERVICING train you for complete professional, electronic work. Get BOTH BIG BOOKS at the special price of only \$9.50 for the two. Send coupon today!

NOW—A RADIO PEN

(Continued from page 487)

getting ready to depart for Florida with this idea in mind.

On the day of departure there came a hurry call from the Big Boss and I repaired myself to his Throne Room with ill-forebodings. Immediately upon entering into his office, I sensed that the air was indeed charged with high electronic tension.

One look at The Sultan did not reassure me one whit. He was chewing his usual big, black stogey, and scowled fiercely. About 60 Decibels. His usual ruddy complexion had taken on a vivid apoplectic Prussian blue. I thought I could even detect small flicks of blue foam near his lips—but in this I may have been mistaken. Without further ado he exploded into this atomic outburst:

"Of all the incompetent, idiotic, nincompoops, you, my asinine Fips, are tops! Here—look at this."

With that he handed me a bulky sheaf of papers neatly stapled together with pale blue legal wrappings. I divined it immediately as an extra generous law suit, which the Metorola Radio people had instituted, not only against the Utis Electronic Corporation, but also against The Sheik and his magazine, as the chief partners in crime.

Not being too well versed in complicated, technical legalities, I tremblingly asked The Maharajah just what this was all about.

"You super-regenerated idiot," belittled the now fully aroused Grand Mogul, "if you had left a spark of honesty in your decrepit, short-circuited carcass, and if you had not been a cock-eyed commonplace copycat, you would have known that the Metorola people have copyrights, trade marks, patents, *habeas corpus* on ANY portable radio set from which a telescopic aerial extends from the top, and which set is used by placing it against the ear.

"Have you ever heard of or seen a handie-talkie in your past, miserable and worthless life? Perhaps that would be too much to expect from a low-oscillating moron of your type. When I gave you the original plans I just sketched the barest outline of the Radio Pen. I naturally supposed that you would not copy obvious designs prevalent in the radio industry. But that was expecting too much of a blown tube of your type!

"Why must you radio engineers continuously steal ideas from each other? Is there no originality in this world? Why couldn't you think up a new-fangled loop aerial instead of copying the handie-talkie type, which you know is covered (and roofed over) by dozens of fundamental, chromium-plated acid-proof patent claims?

"Now observe into what a sticky mess you have gotten the Utis Electronic Corporation, as well as myself. Not only are we going to be the laughing stock of the whole radio world, but it will cost us thousands of dollars to get out of it.

On top of this, the entire Radio Pen has to be designed *all* over again. Now the first thing I am going to do is get YOU out of it—not only out of this mess, but OUT entirely. You are not only OUT, but you are fired as well—NOW!”

During this monstrous high-potential harangue The Shah had become almost incoherent. He was sputtering like a live trolley wire snaking dangerously on the ground. In a flash he picked up one of the latest Radio Pens and flung it at my head. I ducked out of its path in less time than it takes a radar signal.

In making this lightning-like exit, I could not help noticing that the Radio Pen—my own creation—hit squarely against the big calendar not far from the door. I noticed also, with some surprise, the date. It read:

APRIL 1

VIBRATOR AMPLIFIER
(Continued from page 473)

The entire amplifier and power pack were assembled on a metal chassis 9 inches long by 5½ inches from front to back. A front panel 10 inches by 7 inches was cut from a scrap piece of masonite. This carried the controls, terminals, input and output sockets (these were standard wafer type tube sockets).

Although the speaker seems housed in a bass-reflex baffle (Fig. 2) there's really not very much bass about it, although music from records sounds quite well-balanced. The speaker box has a volume of 490 cubic inches and with the two vents—one each side of the speaker—the “bass” resonant frequency is about 200 cycles per second, while the natural diaphragm resonance of the speaker is about 150 cycles per second.

The speaker is a 7P20 Australian made Amplion which has a 20-ounce Alnico magnet, a voice coil diameter of approximately 1 inch, a very light diaphragm and more than average efficiency. This speaker was chosen because it was the largest speaker (of reasonable efficiency) that would fit in the box. Voice-coil impedance is about 3 ohms.

TYPE OF MICROPHONE

It is very undesirable to produce extra distortion from inter-modulation in the first stage (before the unwanted frequencies are attenuated), so the microphone chosen was of the crystal diaphragm type and was worked into a rather low resistance load (250,000 ohms). Suitable types are the D104 Astatic, the 707A Shure and the VT73 Turner. (This last was—I believe—succeeded by a much better type a number of years ago). Recently some dynamic microphones were tried and proved quite satisfactory.

On one occasion when a larger amplifier broke down, this little job was connected to a pair of Long-horn speakers and used for street advertising. A pair of speakers in parallel gave a load of 5 ohms instead of the usual 3 ohms but this did not seem to matter, and the work was carried on successfully.



ALFRED A. GHIRARDI
the man who has started
thousands on successful
careers by making Radio-
Electronics easy to learn.

**I'LL TRAIN YOU FOR
RADIO-ELECTRONICS
in a few short weeks
FOR ONLY \$5 COMPLETE**

**NO PREVIOUS TRAINING NEEDED...
LEARN AS FAST AS YOU CAN READ**

This single, fully-illustrated 972-page RADIO PHYSICS COURSE book is a miracle of modern Radio-Electronic training—by an author who is famous throughout the world for making basic Radio-Electronics easy to learn. Actually, it is the equivalent of 36 complete courses in one. If broken into “course” form and sent in lesson style, you'd regard it as a bargain at \$50 or more. Instead, you buy it complete in book form for only \$5—and you progress as fast as you can read. Many students have completed it within a few weeks.

COMPLETE—PRACTICAL—EASY TO LEARN

RADIO PHYSICS COURSE starts at the very beginning—with Basic Electricity. Then it guides you step by step through the entire field of RADIO-ELECTRONICS-TELEVISION to the latest, most modern developments. Nothing is omitted. Nothing is condensed. Everything is clearly and thoroughly explained. “I have read quite a few texts on Radio-Electronics,” writes C. W. Redish of Astoria, Oregon. “Now, after reading RADIO PHYSICS COURSE, I can see that I wasted my time on the other ones!” Gerard Champagne of Montreal says that Ghirardi's RADIO PHYSICS COURSE at only \$5 explained things to him far better than a course for which he paid \$150!

Ask any successful Radio-Electronic man about RADIO PHYSICS COURSE. He'll know the book—because he probably got his start from it himself!

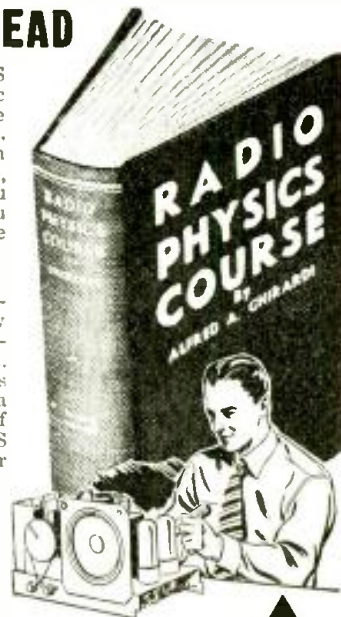

THIS ONE BIG 3½ LB. BOOK DOES THE TRICK

... the same book that is more widely used for home study, by more Signal Corps, Navy, and civilian schools and colleges than any other book or course of its kind!

No matter what phase of ELECTRONICS-RADIO-TELEVISION work you plan to enter, a knowledge of basic fundamentals is absolutely essential. Ghirardi's world-famous RADIO PHYSICS COURSE gives exactly what you need at a price you can afford to pay! Sound, Speech, Music, Electron Theory, Current, Circuits, Resistance, Measuring Instruments, Vacuum Tubes, Detector & Amplifier Tube Action;

Suberhets; Amplifiers, Auto & Aircraft Radio; P. A. Systems; Sound Pictures and Television are but a few of the subjects covered. No previous electronic training is necessary to enable you to understand every word.

Remember! RADIO PHYSICS COURSE has given more beginners their start in this fascinating field than any other book or course ever published. Send coupon today! Read the book for 5 full days. Then, if not more than satisfied, return it — and we'll refund EVERY CENT of your money without question!



**← LEARN ALL ABOUT
ELECTROLYTIC
CAPACITORS**

Want to know how to pick the right capacitor for a job? The advantages and applications of the different types at both high and low frequencies and voltages? How they are made? Their use on a-c or pulsating d-c? Ambient conditions, etc.? How to make measurements, tests, emergency repairs? Then send for Alexander M. Georgiev's “THE ELECTROLYTIC CAPACITOR” — the first book of its kind giving complete, modern data on this vital, widely used component. Fully illustrated. \$3 (\$3.25 foreign).

HAVE A LOOK! You be the judge!

MURRAY HILL BOOKS, INC., Dept. RC-46,
232 Madison Ave., New York 16, N. Y.

Enclosed find \$..... for which please rush my copy of Ghirardi's big 972-page RADIO PHYSICS COURSE book, or send C.O.D. (in U.S.A. only) for this amount plus postage. If not more than satisfied, it is understood that I may return the book within 5 days of receipt for full refund of my money — and no questions asked.

\$3 enclosed (\$3.25 foreign) for a copy of Georgiev's THE ELECTROLYTIC CAPACITOR, or, send C.O.D. (U.S.A. only) for this amount plus postage.

Name
Address
City & Dist. No. State

5-DAY MONEY-BACK GUARANTEE

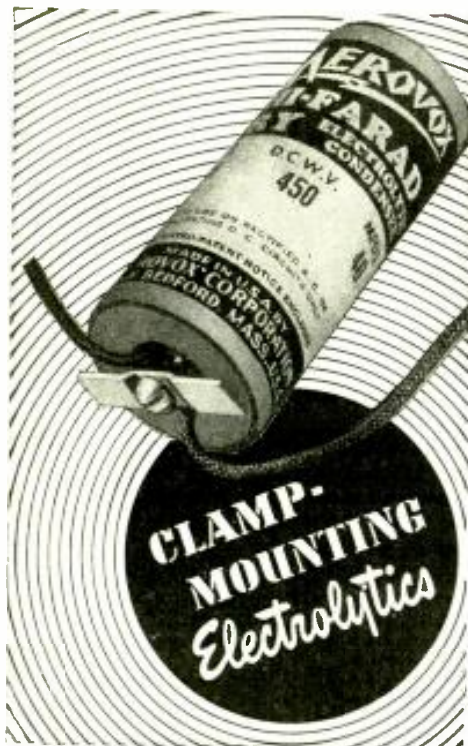

The ideal universal one-hole-mounting electrolytic replacement.

Takes the place of the twist-prong, spade-lug, screw-base, and other similar types.

Type PRV is an exclusive Aerovox design. Available in popular ratings to meet widest range of service calls.

Easily and rigidly mounted, by means of center screw and metal cleat.

Ask Our Jobber . . .

Ask for these handy Aerovox replacement units. Ask for latest Aerovox catalog and free subscription to the monthly "Aerovox Research Worker." Or write us direct.



FOR RADIO-ELECTRONIC AND INDUSTRIAL APPLICATIONS

AEROVOX CORP., NEW BEDFORD, MASS., U.S.A.
Export: 13 E. 40th St., New York 16, N.Y. • Cable: 'ARLAB'
In Canada: AEROVOX CANADA LTD., Hamilton, Ont.

FIVE NEW CIRCUITS

(Continued from page 467)

made of what appears to be fireclay, on which is a wire-wound resistance of 2000 ohms. The chassis is similar to the conventional American type, and is approximately 5 x 3 x 1½ inches, with an overall height, including the speaker and tubes, of about 5 inches. Selectivity is very good, with ample volume for a small room.

A SUPERREGENERATOR

The third receiver (Fig. 3) is a three-tube superregenerative superhet, using a 12SA7, 12SK7 and a 70L7-GT. The 12SA7 is used as a straight mixer, but the 12SK7 is a superregenerative grid-leak detector, regeneration being obtained through an i.f. transformer with a tapped secondary. There is no i.f. stage. The value of the resistor in the anode lead of the 12SK7 must be experimented with as described for Fig. 1. A .00025 mmf condenser connected to the junction of the r.f.c. and that resistor, then grounded, may help reception by by-passing any stray r.f. currents at that point. Cathode detection could be used instead of grid-leak detection by inserting a 50,000-ohm resistor between the cathode and ground, and by-passing it with a 0.1 mf condenser. In this case, the old grid-leak resistance should be removed, but the condenser left in circuit, as it blocks the anode voltage from the grid. Also, a tapped-secondary i.f. transformer is not absolutely a necessity, as the r.f.c. lead that connects to the tap could be connected instead direct to the anode, thus eliminating the need for a tap. In this case, the volume control would also act as the regeneration control.

The addition of the .00025 mf by-pass condenser, plus the substitution of cathode detection, would be an improvement. The tapped-secondary i.f. transformer method of regeneration is better than the untapped type, as when the volume control is also used as a regeneration control, any reduction in screen voltage to reduce regeneration

will also reduce the a.f. output of the tube. As the circuit is given here, reception is loud and clear, with unusually good selectivity, and has ample volume for the average size room.

The chassis is approximately 4 x 6 x 1½ inches, and is conventionally laid out, with an overall height, including speaker and tubes, of about 5 inches. A 3½ inch PM speaker is used.

THREE-TUBE SUPERHET

The fourth receiver, shown in Fig. 4, is another three-tube superhet. This one uses a 12SA7, 12C8 and a 70L7-GT. The 12SA7 is a plain mixer, the 12C8 (a diode-pentode combination) acts as a reflex i.f. detector and 1st a.f., and the 70L7-GT is as before, with the same speaker and smoothing arrangement as in Fig. 3, also using the same unconventional tuning condenser.

The i.f. output of the 12SA7 is fed through an i.f. input transformer to the grid of the 12C8, the output of which is fed through an i.f. output transformer to the diode in the same tube, output of which is reflexed into the grid of the tube once more through the winding of the secondary of the first i.f. transformer. (Compare this 12C8 circuit with the circuit given in Fig. 1.) The a.f. output of the 12C8 is then fed into the 70L7-GT as before. The .001 mf condenser in the ground lead of the 1st i.f. transformer permits radio-frequency to pass, but not the low-frequency current of the reflexed a.f. section. Chassis dimensions are the same as in Fig. 3, with results also about the same, except for a slight increase in volume. This set is about equal in operation to the standard commercial five-tube super.

EIGHT TUBES IN FOUR

The fifth, and last, receiver, is a four-tube superhet using a 25B8-GT, 12SA7, 12C8 and 70L7-GT, which provide the following stages: r.f. converter, 1st i.f., 2nd i.f., diode detector, 1st a.f.,

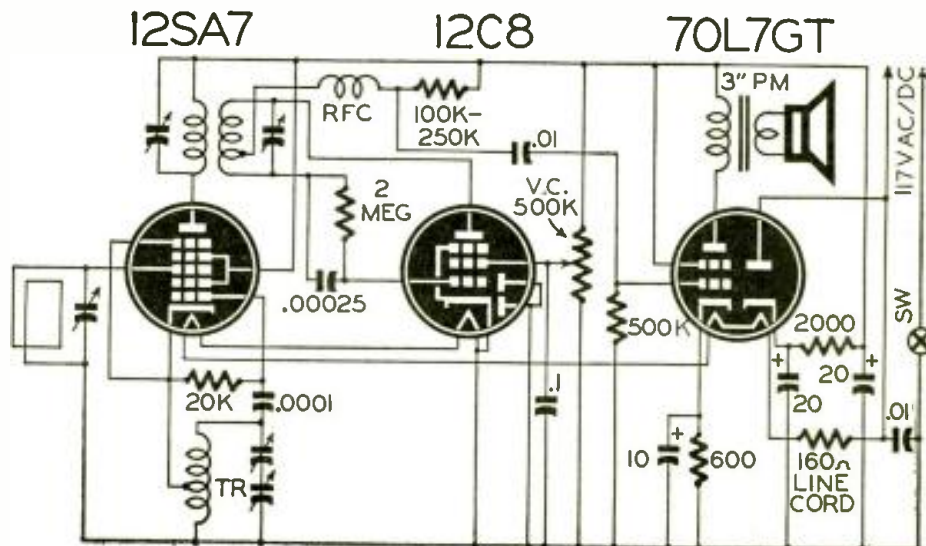
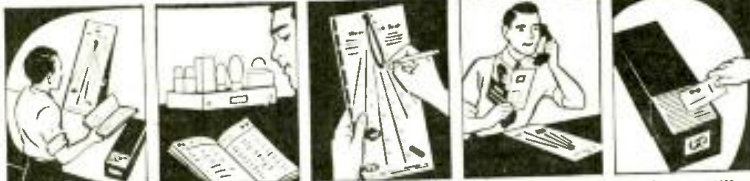

Fig. 3—Superregeneration and the superheterodyne principle are combined in this 3-tuber.

SPEED UP REPAIRS WITH THESE G-C AIDS!

Handle Dial Belt Replacements the Easy G-C Way!



1. To determine proper belt for a given radio, G-C supplies complete Belt Replacement Guide and Measuring Scale.
2. By using G-C Belt Guide, just check model number of the set to determine correct G-C Belt.
3. If you don't know model number or make of the set, G-C Measuring Scale and simple instructions to measure belt.
4. Order belt by number parts distributor. Phone or mail your order to receive prompt service—no waiting.
5. Better still—have a complete G-C Belt Kit on hand. Belts are indexed in permanent steel box with slide-drawer.

FREE TO ALL RADIO SERVICEMEN—68 page G-C No. 345 Belt Guide and Service Book and Measuring Scale. Ask for them at your Radio Parts Distributor.

Get "Smooth-Strong-Correct Fit" G-C Dial Belts
from Your Radio Parts Distributor



GENERAL CEMENT MFG. CO.
ROCKFORD, ILLINOIS



MINIATURE, EXTRA-SENSITIVE HEADPHONES!

IDEAL FOR Amateurs, Servicemen, Commercial Operators, etc.

Manufactured especially for Infantry and Armored Forces; cost the Government approx. \$35.00 per headset. Extremely sensitive phones, with good fidelity characteristics, with matching transformer built-in so that phones work into any hi-impedance output and at the same time are protected from any DC component. Practically indestructible. Light and Compact! Features: adjustable headband; flexible rubber phone cord to provide many years of wear and to guard against moisture; rubber spring clip for fastening to clothing; soft, flexible rubber ear-tips fastened to each phone for comfort and to remove extraneous noises, etc. Supplied with standard phone plug.

PRICE, COMPLETE **5⁹⁵**

Send check or money order for postpaid delivery.

TAYBERN EQUIPMENT COMPANY
120 Greenwich St. New York 6, N. Y.



Photo Electric Unit

For numerous control applications such as burglar alarms, individual safety controls, automatic counters and in conjunction with a chime or bell to announce entrance of people in stores and offices. For AC. Complete with all tubes and SPDT control relay. Net

\$9.45

ADSON RADIO CO.
321 FULTON ST., NEW YORK 7, N. Y.

RADIOSONDES \$1

Miniature H-F transmitters with temperature, humidity and barometric elements. Used for radio weather reporting. Gov't surplus, as is. An unequalled bargain for parts. Limited quantity. Send your dollar bill to:
W. H. DEACY, 231 E 76, New York 21

Postpaid

CRABTREE'S WHOLESALE RADIO

2608 Ross Ave.
DALLAS 1 TEXAS

GOVERNMENT SURPLUS PURCHASE!

PHANTOM ANTENNA (A27)

Frequency Range: 2 to 4.5 M.C. 18 Gauge Steel Case, Panel and Cover, Calibration chart. Approximate value, \$25.00. Our price \$4.50.

O-1 Milliammeter, \$3.00

G.E. (NE45) Neon Glow Lamps, 30c ea.

Box of Ten, \$2.50

RADIO HAM SHACK

63 DEY ST., New York 7, N. Y.

RADIO SERVICEMEN: RADIO PARTS—TUBES

BARGAIN PRICES—NO PRIORITIES

PHONO MOTORS, 9-inch T.T. \$2.99
CRYSTAL PICKUPS, 1 oz., 150 V. 2.79
FILTER COND., 20-20 Mfd., 150 V.39
BY-PASS COND., .01, .02, .05, .1—600 V.07
LOOP ANTENNA (High Gain) ... COIL SETS69
ANT. & OSCIL. or ANT. and RF COIL SETS69
RESISTOR KIT—50 Ass't'd. 1/3 to 1 Watt.99
Write Today for Bargain Bulletin
RADIO DISTRIBUTING CO., Pasadena 18, Calif.

Instead, the antenna coil has a special primary winding of about twenty turns of No. 24 wire, each end of which is connected through a 0.1 mf condenser to the 117-volt line.

The same type of tuning condenser is used as in previous circuits given here. There is no line-cord resistor because the total filament voltages add up to 120 volts. A 2-volt pilot light is connected across the output transformer secondary. (This is not to be confused with the miniature 117-volt light which illuminates the dial.) This 2-volt light does not "light"—it merely provides a resistance that varies with the load on the speaker, and thus provides a certain amount of volume expansion. Different lamps ranging from 2 to 6 volts should be tried. This method of volume expansion is quite prevalent in some foreign countries, notably England, where special lamps have been developed for this purpose. (Such expanders were described in the April, 1937, issue of *Short Wave and Television*.—Editor)

In all the foregoing circuits careful shielding is necessary, particularly with the regenerative tubes. However, results seem to justify the care needed, for all the receivers described gave better results than were expected, particularly the four-tube superhet, the results from which, in the opinion of the writer, are as good as many a ten-tube commercial job!

LAMENT FOR THE DIPOLE

FM has been shifted from the old band at 42-50 megacycles up to the region between 88 and 108 mc. This means that dipole antennas will have to be reduced in length to approximately half what they were before.

Our office bard was thereby stimulated into song (to the tune of "They Cut Down the Old Pine Tree").

Oh, they cut down the old dipole
And they moved to a new frequency;
To make room on the band
For the amateurs, and
The radio citizenry.

—E.A.W.

CORRECTION

By an accident of draftsmanship, polarity of the 8µf condensers in the figure at lower right corner of page 271, January *Radio-Craft*, was reversed. The figure was part of an article "Hi-Fi Amplifier Contest," by John W. Straede.

We owe this correction to Mr. Taylor L. Winn of Ovid, Colorado, who kindly pointed it out to us.

HAZELTON INSTRUMENT CO. Electric Meter Laboratory

Electrical instruments, Tube Checkers, and Analyzers repaired.

140 Liberty St., New York, N. Y.
Tel. BArcly 7-4239

THE CRYSTAL FILTER

(Continued from page 476)

so will its loudness. At a certain critical setting, the tone will suddenly become very loud and seem to stand out above all else. The note will have a peculiar ringing quality, particularly if a rapidly keyed signal is being received. This is an indication that the signal is coming through exactly at the peak crystal response frequency.

It is important to learn to recognize the characteristic note that indicates peak response. Tuning across the entire signal a few times will show how much the signal is attenuated at all other settings, and will emphasize the necessity for accurate tuning with the crystal circuit in operation.

Ordinarily it is not advantageous to leave the crystal circuit in operation at all times, since it is too easy to skip over a signal when tuning rapidly across a band of frequencies. More common practice is to use standard i.f. operation for searching and preliminary tuning, then to switch in the crystal circuit if more selectivity is needed to cut out interference.

CONTINUOUS WAVE RECEPTION

It is the process of switching from i.f. to crystal operation that creates the most difficulty in the use of a crystal filter circuit with c.w. signals. Since the i.f. selectivity curve is so much broader than that of the crystal, a signal which comes through the i.f. circuits with plenty of amplitude can be greatly attenuated by the crystal if that signal is not close to the peak crystal response frequency. Therefore, to avoid the possibility of losing a signal completely, it becomes necessary to establish some means of bringing the signal to within a few cycles of the crystal frequency before the crystal is cut in.

The required accuracy of adjustment can be obtained through a knowledge of two factors: the side of zero beat on which peak response occurs, and the approximate pitch of the beat note at this point. These factors are determined by the setting of the b.f.o. pitch control. Accordingly, it is a good idea to set the receiver up on a good steady c.w. signal before each period of operation, at which time it will be possible to establish these factors as desired. Then, if the b.f.o. pitch control is not disturbed, it will be easy to bring the signal very close to peak crystal response while still on i.f. operation. When the crystal is cut in, only a slight tuning readjustment will be necessary.

MODULATED WAVE RECEPTION

The use of a crystal filter for receiving amplitude-modulated signals is very simple compared to that for c.w. operation. While a c.w. signal is essentially of one frequency only, a modulated signal occupies a band of frequencies several kilocycles wide. In spite of the fact that the crystal band-pass might

(Continued on page 507)



Amateurs...

DO YOU know where you are in the Radio Spectrum? With a Glaub Xtal you can be sure. Our Xtals are ground to within .03% of specified frequency and guaranteed, with a temperature coefficient of less 3 cycles per megacycle per degree centigrade. They can't be beat! Attractive, convenient holders to fit any set. A custom built Xtal to your specifications at a standard price.

DELIVERED 48 HOURS AFTER RECEIPT OF ORDER
LET US PUT YOU IN YOUR PLACE ON THE AIR!

PIONEER ELECTRIC COMPANY

Western Distributors of Glaub Crystals

3700 East Olympic Boulevard • Los Angeles 23, California

HAM HEADQUARTERS FOR Equipment and Information

EXTRA SPECIALS

- 24 G Tubes Limited Supply \$1.90 net
- Leach Relay Low Loss D.P.D.T. 6V. D. C. Coil \$1.75 Net
- 3-3 MFD. 600 W.V. Oil Filled Condenser 99c Net
- Shure T17B Mike with Relay Switch \$3.10 Net

Mail Orders Promptly Filled
Amateurs to Serve You

Write Dept. RC
W6SCQ—W8WLG/6—W6NAT
W6SSU



FOR YOUR NEW RIG

Monitor Crystals 7 MC. Band
Type 43B \$2.80 net

Also complete Line of:

NATIONAL	EIMAC
JOHNSON	JONES
OHMITE	AMPREX
TAYLOR	ADVANCE
BARKER-WILLIAMSON	
HALLCRAFTERS	

Radio Product Sales Company

238 WEST 15TH STREET

LOS ANGELES 15, CALIFORNIA

PRospect 7471

FOR EVERYTHING IN RADIO

WRITE

Leo, W9GFQ

For Fast Delivery!



Get Leo's own Personal, sudden service on your radio and electronic needs. Quick delivery, lowest e.m.s. liberal trade-in allowances.

SERVICE DEALER NEEDS



WRL MULTITESTER
Steel case with 30-60% angle
Cat. No. 16-491 \$1875
Less Leads

Handles AC DC Voltmeter, DO Milliammeter, high and low range Ohmmeter. 3" meter with sturdy D'Aronson movement. Size 5 1/2 x 8 x 3 1/4.

A complete stock of tools, replacement parts, test equipment, intercom and public address systems . . . everything for the progressive service dealer.

FOR EXPERIMENTERS

PHONO AMPLIFIER KITS



Complete with tubes, speaker, stamped chassis, and all resistors and condensers

Cat. No. 7-271 \$9.50 ea. Lots of 3, ea. \$915

Crystal sets, Antenna Kits, Code Oscillator Kits, Transmitter Kits, and many other items for the experimenter and radio enthusiast.

HAM NEEDS

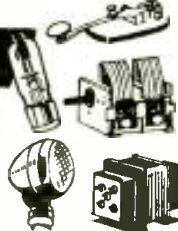

Transmitting tubes, condensers, mikes . . . everything for the Ham. One of the country's largest stocks of Ham equipment. Write Leo, W9GFQ, today, and be first with the latest. We invite inquiries for special equipment of all kinds.

TRANSMITTERS

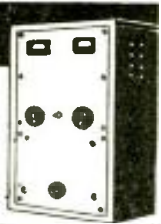

For peak performance and more dollar for dollar value, get a WRL Transmitter Kit . . . designed in Leo's own laboratories . . . tested and proven. Available in 15, 35, 70, and 150 watt kits as well as kits custom built to your own specs. Write Leo today for complete details, prices and terms.

RECEIVERS



Here are just a few of the many well-known receivers offered by Leo:

- Hallierasters SX-25 \$ 94.50
- Hallierasters S-20R \$ 60.00
- Hallierasters SX-28A \$223.00
- Eriophone EC-1A \$ 29.50
- Hammarlund HQ-129X \$129.00
- National NC-2-40C \$225.00

Write for details of our trade-in plan and easy terms

FREE! 52 PAGE FLYER

52 pages packed with real buys in radio, electronic, and general merchandise.

Giant Radio Map (size 3 1/2' x 4 1/2') 15c

Handy Tube-Base Calculator 25c

Address Dept. RC-4
Council Bluffs, Iowa



Formerly Wholesale Radio Laboratories

WAVES AND PULSES

(Continued from page 471)

breaking down of energy stored in the electric fields of the two .0005 μ f condensers. The two triodes may be considered to function alternately, each tube producing a phase shift of 180°, thus sustaining oscillations. When not externally controlled or synchronized, the circuit is said to be *free-running*.

Output square waves (of opposite polarity) may be taken from the plate of either triode, as shown in Fig. 5. These waves are extremely rich in harmonics, have steep leading and trailing edges.

The voltage drop across any of the cir-

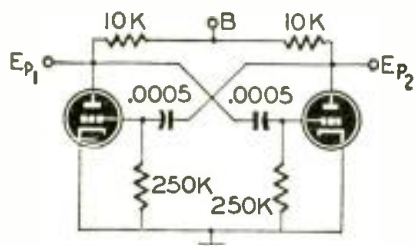

Fig. 5—Free-running multivibrator circuit and a pair of typical rectangular waveforms.

cuit elements may be taken for the multivibrator output.

Frequency of oscillation depends primarily upon the discharge time of the .0005 μ f condensers—which, in turn, is determined by their capacity and the resistance of the circuit. By proper choice of these values, the oscillating frequency may range from 1 cycle (or less) per minute to more than 50,000 cycles per second.

At very low or very high operating frequencies, the stability of a free-running multivibrator may be somewhat poor.

To avoid this disadvantage, multi-

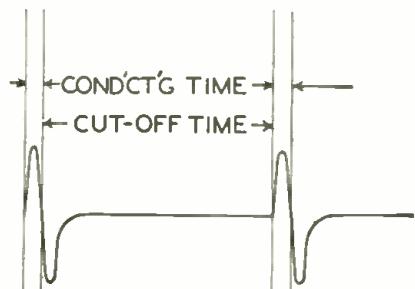
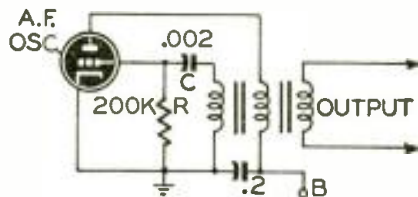

Fig. 6—A low-frequency blocking oscillator.

vibrators are sometimes synchronized with an oscillating or pulsing frequency from an external source. This forces the circuit to oscillate at exactly the frequency, or a harmonic multiple, of the synchronizing voltage. No longer free-running, such a circuit is said to be a *driven* multivibrator.

There are many varieties of multivibrators.

Cathode coupling may sometimes be employed between the two tubes. The two triodes may be replaced by two tetrodes, or two pentodes.

BLOCKING OSCILLATORS

Non-rectangular pulses—of low-order harmonic content—can be generated directly by a means of blocking oscillator. For this purpose, any type of self-biased sinusoidal oscillator may be employed.

Blocking of an oscillator is caused by circuit conditions that cause a negative charge to be built up on the grid which biases the tube beyond cut-off. It remains inoperative until charges on the circuit elements (grid resistor and condenser) return to normal, when the tube again conducts and the entire process is repeated.

The rate of recurrence of these operating conditions is determined by the R-C time constant of the grid circuit.

For operation at audio frequencies, such an oscillator can be arranged in a circuit in which the tube is cut off at or

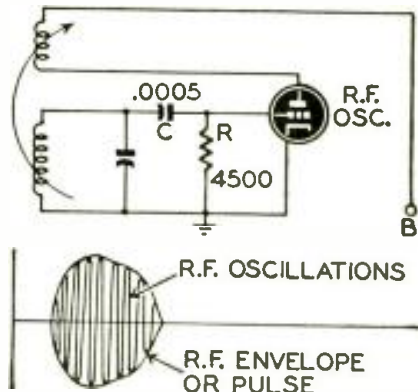

Fig. 7—R.F. blocking oscillator and pulse.

before completion of one cycle of oscillation. Circuit and typical waveforms are shown in Fig. 6.

The tube (Fig. 6) is allowed to conduct for only one-half of a normally complete cycle, when blocking action drives the grid beyond cut-off. Oscillations do not start again immediately, because the flow of electrons in the grid circuit (during the time the grid was positive) built up a sufficient charge of electrons on the grid condenser C to hold the tube cut off until a considerable amount of the charge leaks off through the grid resistor R.

The time between pulses is determined largely by the value of grid resistance. Duration of the output pulse is determined by the grid condenser.

For operation at radio frequencies, a blocking oscillator is arranged in a circuit in which each cycle of oscillation causes the grid to become progressively more negative until the tube is biased beyond cut-off. This action is sometimes known as "squegging." Circuit and typical waveforms are shown in Fig. 7.

Although the biasing action is relatively slower, it should be noted that the

tube oscillates at radio frequency during each brief period before the tube is blocked or biased beyond cut-off. Thus, the circuit is effectively oscillating at *two* frequencies: the radio frequency or natural frequency of the L-C tank circuit, and the pulse recurrence frequency determined by the R-C constant of the grid circuit.

The output waveform of such a blocking or squegging oscillator has relatively poor definition. But it is found to be acceptable in several types of radar transmitters requiring no great amount of pulse stability.

RINGING OSCILLATORS

Non-rectangular pulses may also be generated by a *ringing oscillator*. But operation of such a circuit depends upon a negative-going square wave from an external source.

A typical circuit is shown in Fig. 8.

When not triggered, the plate current of the tube is allowed to flow through the inductor of a parallel tank circuit. When a negative-going square wave is applied to the grid of the triode, the tube is suddenly cut off and the tank circuit is shocked into oscillation.

Such oscillations are constant in frequency. But they are highly damped, and therefore continue for only a brief period. The damped "train" output (Fig. 8) may be limited and amplified to produce a series of alternately positive- and negative-going square waves. Or, more resistance may be added to the tank circuit to increase the damping effect—and thus permit *only one-half of an alternation*—or a single impulse—to appear in the output of the ringing oscillator.

Frequency of oscillation is determined by the L and C constants of the parallel tank circuit. But individual pulses will correspond *in the phase* to the leading edge of the negative-going input trigger wave.

Duration of the output pulses is also a function of the resonant frequency of the tank circuit.

After the circuit (Fig. 8) is shocked into oscillation, initial alteration of the output will be in a negative direction—since the tank circuit is in the cathode of the tube. When the tank circuit is located in the plate of the tube, the first output alternation will be in a positive direction.

Regardless of the output polarity, however, the input waveform must be a negative-going square wave of sufficient magnitude to cut off operation of the triode.

When a source of square-wave voltage is available, transformers may also serve to form low-order harmonic impulses. Typical circuit is shown in Fig. 9.

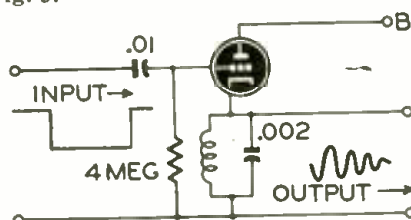

Fig. 8—Ringing oscillator and damped pulse.

Voltage is induced in the secondary of a transformer only when the primary voltage is changing. Since the voltage changes of a square wave are very abrupt, such an input wave (Fig. 9) will

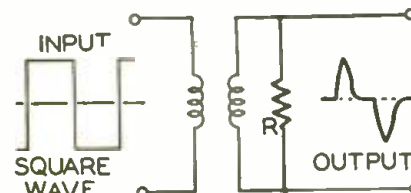

Fig. 9—Transformer pulse-producing circuit.

cause a relatively high secondary voltage to be induced during the brief periods of primary voltage change. This re-

sults in an alternately positive- and negative-going output pulse form, similar to that shown in the figure.

Primary and secondary of the transformer are usually loosely coupled to reduce undesirable effects of mutual inductance. A resistor R is placed across the secondary to prevent possible oscillation.

Non-rectangular pulses may also be formed by applying a pure sine wave to a saturable inductor. This is a special type of non-linear coil, in which a low value of current produces magnetic saturation. Typical circuit and waveforms are shown in Fig. 10.

When a rapidly changing current is

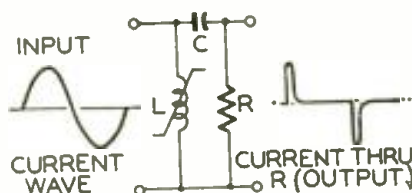

Fig. 10—Pulsing with a saturable inductor.

applied to a saturable inductor, impulses will be formed during the maximum rate of change of current flow through the coil. Thus, when a pure sine wave is applied to the circuit (Fig. 10), the inductor produces sharp positive and negative impulses across its terminals during the time the sine wave is passing through the narrow region of magnetic saturation.

Resultant output through resistor R is a very narrow current pulse.

Electricity

Models range from 350 to 35,000 watts. A. C. types from 115 to 660 volts, 50, 60, 180 cycles, single or three-phase and 400, 500 and 800 cycles, single phase. D. C. types from 6 to 4000 volts. Also available in dual voltage and special frequency types.

Model shown is from W2C series; 2000 to 3500 watts; powered by Onan-built, two-cylinder, water-cooled engine.

D. W. ONAN AND SONS
2426 Royalston Avenue
Minneapolis 5 Minn.

Write For Folder 690-A describing complete Onan Line

SOUND VALUES at TERMINAL RADIO

High Quality CARBON-TYPE HAND MICROPHONE

Made by Shure for the U.S. Army Signal Corps—type T-17. Excellent reproduction of voice frequencies. A real buy at Terminal!

- ★ Ideal for Radio Transmitters, Mobile P.A. Systems, Call Systems, etc.
- ★ 200 Ohm, Single Button, High Quality.
- ★ Press-to-talk Button Operates Relay and Microphone.
- ★ Built-in Filter for Suppression of Carbon Hiss.
- ★ Sturdy Construction—Can Really Take a Beating.
- ★ Guaranteed Brand New, in Sealed Cartons.
- ★ Complete with 5 Feet. Three-Wire, Rubber Covered Cable and 3 Circuit Phone Plug.
- ★ Moisture-Proof Cover.

\$2.89 net
Add 15c for shipping charges when ordering by mail.

Terminal Radio Corporation

85 CORTLANDT ST. N. Y. 7, N. Y.
WO 2-4415

CHECK THESE PRICES!

Here are just a few sensational values on our complete stock of first-quality merchandise. Send for free catalog for complete list.

ALMOST ALL TYPES OF TUBES IN STOCK. MAIL IN YOUR ORDERS FOR ALL TYPES NEEDED, NOT JUST THE CRITICAL NUMBERS, AND WE'LL TRY TO FILL THEM COMPLETELY.

TEST LEADS—50', extra-heavy phono-needle type black and red Prods. 5 KV insulation; per pr.—50. **RF Chokes**, 2.5 MH-150 MA, ple-wound—29. **AUTO ANTENNAS**—standard 3 section type, complete with leads, 66"—\$1.50; 96"—\$2.95. **RESISTOR KITS**—50 2 Watt, all standard useful sizes—\$1.95. **CIRCUIT BREAKERS**—20 Amp, made for military use—\$1.25.

Just off the press—"Inside The Vacuum Tube," by Rider—a valuable addition to your technical library—\$4.50. **CARBON MIKES**—Universal Model W—\$2.40. "Home Broadcast" type; with built-in switch and instructions—\$3.60. Gold-plated midket type Signal Corps single button mike, with stretched durable aluminum diaphragm—just the thing for secret or concealed pickups, lapel mikes, or wherever a compact, high quality unit is needed. Super-Special—\$3.95. Single-button mike transformers—\$3.69.

All-Purpose Neon Pocket Tester, 60 to 550 Volts. Indicate all kinds of current AC, DC, or RF, and comes complete with instruction booklet outlining various tests on radio sets, including the location of fading, dead stages, shorts, and making screen-grid and plate circuit tests. .35 ea. Per doz. on beautiful display card—\$3.50

Tubular Condensers—guaranteed one year. Prices in lots of ten, either one type or assorted. 100 Mf., 25V—35; 50 Mf., 150V—45; 20-30 Mf., 150V—10; 20-20 Mf., 150V—30; 25 Mf., 25V—20; 20 Mf., 150V—20; 10 Mf., 50V—15; **PAPER CONDENSERS** all 600V—25 Mf.—20; 1 Mf.—10; .05 Mf.—.08; .02 Mf.—.08; .01 Mf.—.08; .008 Mf.—.05; .005 and smaller—.07 ea. **MICA CONDENSERS**, 1000V test, 600 WV, any standard size—.15 ea.

110V 60 Cy. Two-Post record changers—play 12-14" or 12" records **INTERMIXED**. The only low-priced changer on the market with this feature. Includes high-grade Shure crystal pickup—\$22.50. G.P. SPDT Microswitches—.50 ea. Stromberg-Carlson 30 H, 250 Ma, 35 ohm choke. Fully shielded in black crackle case—1.98.

SURPLUS Army transceivers—cover low frequency amateur bands as well as VHF band (complete with 15 tubes, less power supply—39.95. Send for technical data. **RELAYS**—1-pole (3 make, 1 break) 400 ohm. AC or DC—1.00; DPDT heavy duty type 50 ohm coil resistance—suitable for high-power switching 1.50. SPST—15 ohms AC-DC—.45.

Banish portable battery troubles—replace with a GTC Portapower—Converts 110V AC to 1½ and 90V DC, and fits average size battery compartments. No wiring changes necessary, as unit has sockets for any standard battery plug. The first cost, 8.90 is the last cost. Beautiful silver-tone Modern Walnut cabinets in original cartons. Large enough for most chassis and only \$1.50 ea. #4619, with glass and plastic escutcheon—9x10½x16½" high; or #1923—11x18x20" hkh.

ROTARY SWITCHES SPDT shorting type—.15; Ceramic switches—for hi-freq. use, 3 pole, double throw and 4 pole double throw (shorting type)—either type—.47 ea.

METER RECTIFIERS—4 wire, full wave—.99. **MOTOR STARTING CONDENSERS**, 110V 85-115 Mfd 3-second start, universal type for refrigerators, washers, etc.—1.25 ea.

AMPLIFIER Foundation Unit, 7x17x9"—chassis 3" high, finished in beautiful gray ripple finish—2.70. We have a complete line of ICA chassis and cabinets at comparably low prices.

BUFFALO RADIO SUPPLY

219-221 Genesee St., Dept. C-4
Buffalo 3, New York

WHAT STRANGE POWERS

Did The Ancients Possess?

WHERE was the source of knowledge that made it possible for the ancients to perform miracles? These wise men of the past knew the mysteries of life and personal power. This wisdom is not lost—it is withheld from the masses. It is offered freely TO YOU, if you have an open mind. Write for free sealed book. Address: Scribe MoTab.

The ROSICRUCIANS
San Jose (AMORC) California

Make your own Talkies
WITH PATD. **FILMGRAPH** RECORDER
and Instantaneous Permanent
PLAYBACK UNIT. Lengthy Recordings;
Clear, Powerful; Eliminates Titles.

CIRCULAR FREE

MILES REPRODUCER CO., INC. 812 BROADWAY, N.Y.3 RC-4

NEW RADIO PATENTS

By I. QUEEN

MICROPHONIC TUBE

Jerome Rothstein, Belmar, N. J.
Patent No. 2,389,935

ORDINARILY a microphonic tube is a lamentable component, to be discarded at the earliest moment a replacement can be located. In this case, a microphonic tube is deliberately designed for particularly useful electronic applications.

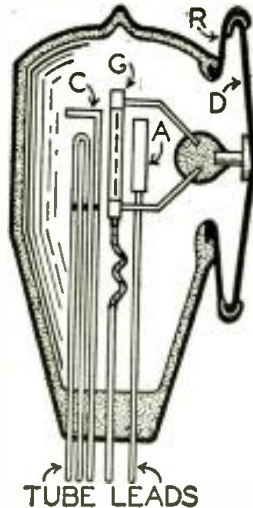

The vacuum tube is shown with cathode, control grid and anode, but auxiliary elements could be added. A circular flexible diaphragm (D) is welded at its periphery to a metal ring (R) which in turn is sealed to the edge of a large aperture in the glass envelope. The center of the diaphragm is connected to a large glass bead which supports the control grid. The grid lead from the base is flexible to permit movement.

Vibration or displacement at the diaphragm is transmitted to the control grid. Therefore, corresponding changes of amplification factor occur and may be indicated or recorded in the plate circuit.

This new tube can be used to measure wind velocity, liquid pressure, faint sounds and mechanical stresses. The center of the diaphragm may be connected to a distant object by a taut wire if desired.

THYRATRON INVERTER

Henry Carleton, Washington, D. C.
Patent No. 2,390,508

IT IS usually simpler to obtain d.c. from a.c. than vice versa, especially when high power is involved. This invention inverts power without the use of moving parts, requires only few components, and provides an adjustable frequency.

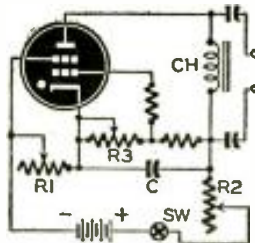

The d.c. source is connected across R1, R2 and C. R2 is much greater than the other resistor. With the switch closed, the condenser C begins to charge and the current flow gradually decreases to zero. As a result of this current a high negative bias appears at the screen grid, but this quickly drops to zero. Simultaneously, the control grid and anode voltages rise rapidly in a positive sense. These three changes all tend to break down the thyatron tube at some instant before complete condenser charge.

When the tube ionizes, the condenser discharges through coil CH, resulting in an oscillatory pulse, until the condenser charges to a sufficiently high reverse potential which cuts off the tube. The output appears across the coil (through fixed condensers).

R2 adjusts the frequency, while R1 and R3 determine the optimum instant for tube breakdown.

FM DETECTOR

George C. Sziklat, Princeton, N. J.
Patent No. 2,373,616

IT HAS been discovered that a super-regenerative circuit provides a very sensitive detector of FM energy and requires no limiter. The figure shows two such circuits with secondaries oppositely mistuned by a frequency exceeding the maximum frequency deviation of the carrier.

The time constant of each circuit is adjusted to some super-audible frequency between 80 and 200 Kc, the smaller providing greater output. The super-regenerative circuit characteristics are illustrated in the curve which shows a substantially straight portion between peaks. Since the tubes are run between cut-off and saturation, limiting action is automatically provided for. High sensitivity is obtained whether the input is an antenna or an I.F. amplifier output.

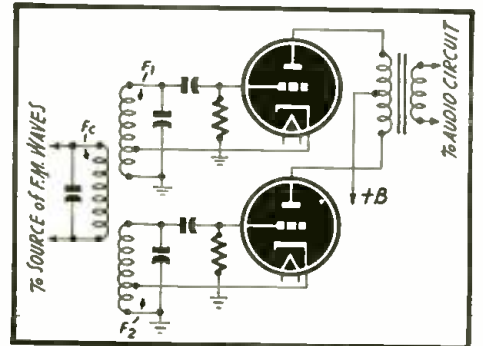

GENERATOR REGULATOR

William C. Grabau, Brighton, Mass.
Patent No. 2,390,214

THIS electronic regulator limits the voltage fluctuations of a.c. generators. Use is made of two full-wave rectifiers and a gas-discharge (Continued on page 507)

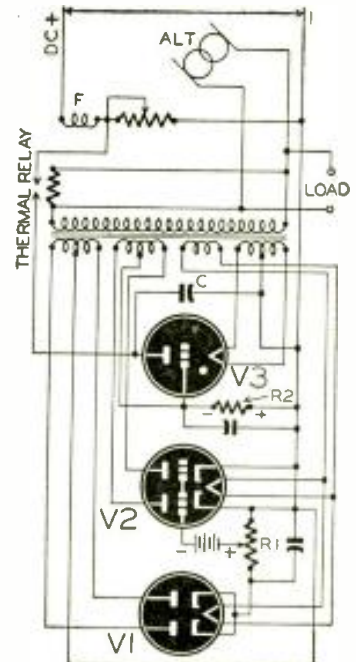

RADIO TO THE MOON

(Continued from page 464)

Knowledge that we have this power to carry through the vacuum of outer stellar space, proved by the echo from the satellite, means even more: that we can extend man's control and influence into voids far removed from the earth.

What I mean by control is our everyday ability to push a button and re-route a railroad train, or press a switch and light up a room, or dial a phone and talk across a city.

On January 10th we learned we could push a button and make *things happen in outer space*, for the calculated intensity of our signal delivered on the face of the moon, sufficient to produce an echo on earth, is far more than needed to control a device on the face of the moon, or anywhere in space between us and it.

It's no trick at all, for instance, to control a pilotless plane or operate a driverless vehicle on the face of the earth by a simple remote control box. We did that five years before the war. But after January 10th we know that we can do it *as far away as the moon*, or on the face of the moon if you like.

That really is the significance of our discovery. Not that with a dozen years of delicate watchlike radar improvement we could map the moon, now fairly well done with a good telescope. By the time we map the moon by earth radar, these radars will be controlling an intersatellite service which, being on the spot, will be able to do map making as a subsidiary or incidental assignment. In short, radar has presented a means of control and communication well in advance of man's ability to project himself in space. And it may well be the means which will lead to it.

To provide any sort of concrete proof that our radar was reaching the moon it was obvious, lacking a lunar receiving station to report on our signals, that we had to send a signal to the satellite *so strong* that we could check our own echo.

For this we used 64 dipole antennas in phase with a reflecting surface behind—standard radar equipment merely doubled in size, power gain approximately 200. Our transmitter operated on 112 megacycles, peak power around 4 kw, pulse duration $\frac{1}{2}$ second, repetition rate 1 pulse each 5 seconds. The transmitter was crystal controlled, using a 500 kc bar and employing frequency multiplier stages to reach a final amplifier output of 112 megacycles. This final power amplifier used during early tests and prior to the announcement of the contact, used two Eimac 1000-T tubes in a conventional v.h.f. push-pull circuit.

Far more complex was the receiver which, built with a sensitivity of 0.01 microvolts, is about 200 times as sensitive as the most progressive type communications receiver available to the public today. This sensitivity was absolutely necessary, our closest calculations showed us.



UNIMETER

This unit fulfills an extremely important need for general utility portable service equipment. It has wide range coverage for both a-c and d-c measurements of voltage, current measurements on d-c and the popular ranges on resistance.

The UM-3 is designed to clearly indicate all the functions which aid in the prevention of application of high voltages when preparing for current or resistance measurements.

Other G-E units for better servicing include: Tube Checker TC-3, Unimeter UM-4, and Oscilloscope CRO-3A.

For details write: *Electronics Dept., Specialty Division, General Electric Company, Syracuse, New York.*

Electronic Measuring Instruments

GENERAL ELECTRIC



177-E1

UM-3



Astronomically, we knew that the surface of the moon was lava which, measured on earth, has a dielectric constant of about 6. This meant that about 16 percent or 3 watts of our energy striking the moon would be reradiated in all directions. Our receiver, therefore, would have to be sensitive enough to pick up signals not stronger than would be sent from a 3-watt walkie-talkie operating on the moon.

Basically, the receiver is a 4-mixer superheterodyne with all but one of the mixer injection frequencies controlled by the transmitter crystal to provide locking with the transmitter frequency. The fourth mixer is provided with an adjustable-frequency crystal to establish the final i.f. for the exact

frequency to be received.

The receiver's input frequency differs from the transmitter frequency by an amount depending upon the *Doppler* .
(Continued on page 502)



Signal Corps Photo
Part of the supersensitive receiver and test equipment used for the measurements.

Radio Headquarters

for 25 years



We ship at once—parts, equipment, whatever you need!

This house began its career almost as early as Broadcasting itself! Today, 25 years later, we're the world's largest radio supply house! Standard Lines: National, Hammarlund, R. C. A., Hallicrafters, Bud, Cardwell, Bliley, and all the others!



SUPERSPEED SERVICE Orders shipped out same day received, on most goods.



ENGINEERING SERVICE If your engineering problem requires special equipment, we'll make it

FREE!

Latest bargain flyer includes test instruments, record changers, communication receivers, ham transmitting tubes and a host of electronic items you need today.



Originators and Marketers of the famous

Lafayette Radio

Radio Wire Television Inc.

NEW YORK 13 BOSTON 10 NEWARK 2

Cut out coupon, paste on penny post card, mail today

R. W. T. Dept. RC-6
100 AVENUE OF THE AMERICAS, NEW YORK 13

Gentlemen: Send me FREE copy of your Latest Bargain Flyer C-36, packed with recent electronic equipment and components.

NAME _____

ADDRESS _____

CITY _____ ZONE _____ STATE _____

RADIO TO THE MOON

(Continued from page 501)

Effect due to the moon's velocity. When the moon rises we are speeding toward it 834 to 626 miles per hour, Doppler Effect increasing the frequency of the echo signal between 279 and 209 cycles from the transmitted signal. At moonset, we recede from the satellite at from 891 to 578 m.p.h. which decreases the echo signal frequency anywhere from 287 to 188 cycles. This exact frequency measurement of the Doppler Effect on our radar signals, incidentally, provided a proof positive of contact with the satellite.

The experiments which established the first contact with the satellite on January 10th are, of course, only the merest beginning of developments which may rapidly occur in a short space of time.

In establishing our 476,000 mile contact we now have an invaluable circuit through the ionosphere which, our experiments show so far, is interrupted by unexplained phenomena. For instance, while it is too early to say with assurance, sun spots appear to disrupt continuity of the circuit, whereas for terrestrial straight-line u.h.f. they have little or no effect. Also on one or two occasions we contacted the moon before it rose over the horizon. And we are just beginning research on the effect of radically shifting frequency, say from the present frequency to 500 megacycles, or to 1000 megacycles, and the concurrent gain realized from a very large parabolic antenna. What will happen then? We will find out!

These are vast fields of unanswered scientific questions to which we may apply to outer space a research weapon as valuable to man's electronic knowledge as the microscope to bacteriology.

Another question of prime importance: just how far will our signals really travel? Calculations show our radar transmitter, using a peak power of from 3 to 4 kw (which actually is not very large), produced a reradiated power from the moon of 3 watts, indicating a signal strength delivered to that satellite easily equal to that received by rural listeners of our network broadcast programs.

First conclusion, of course, is that we will not have any trouble at all broadcasting programs to a moon audience, when and if anyone wants to go there and listen. By the same token if we want to remotely control devices between the earth and the moon, or on the surface of

the moon itself we could do it without too much difficulty from an electronic standpoint. But the question leads to this: if our signals are now strong enough to exercise control on the moon, how much of a signal are we getting to Mars and Venus?

Interplanetary contact rests on the development of improved equipment: a superpower transmitter, a razor-sharp



Acme Photo

Antennas at Evans Signal Laboratory, Belmar, New Jersey, where the moon contact was made. The big one in foreground sent the signals.

antenna beam and an increased receiver sensitivity. Only when we can deliver a signal to these planets so strong that we receive an echo from the impact, can we know we are getting there. When we receive this echo, we will know, *ipso facto*, we can exercise electronic control in the void between and on that planet.

With continued and accelerated research at the Signal Corps Engineering Laboratories we hope to break through to these new horizons of man's ability to talk and impose his will in space.

No nation on earth wants another war. And it is everyone's hope, and the end toward which we are working, that our research will benefit mankind and make this world a better place to live in.

But if America is ever faced with a push-button war, the Signal Corps will design the button. . . .

MOON-RADIO PREDICTED IN 1927

READERS of the Gernsback publications will not be too surprised to hear of radio-radar contacts with the moon, since such communication was accurately predicted 19 years ago in an article by Hugo Gernsback, entitled: "Can We Radio the Planets?", and published by him in his former magazine, *Radio News*, February, 1927.

The article foretold exactly the results

now had by the Army Signal Corps scientists. An illustration pictured a radio transmitter on the earth with the moon overhead and the reflected radio beam coming back. At each side of the earth an observer was shown monitoring the transmitter and received waves, with a clock indicating two and a half seconds elapsed time between the outgoing and incoming signal.

"Can We Radio the Planets?" Mr. Gernsback stated, does not necessarily mean that the author has attempted in this article to design apparatus to transmit and receive intelligence to and from other worlds, although such a possibility is discussed. Rather he brings forth an entirely new point, suggesting seriously—by means of the beam system—to send and receive back the same beam,

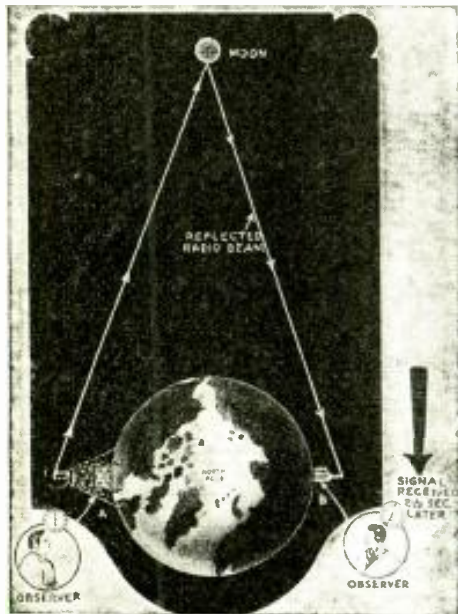

Illustration from Feb. 1927 issue *Radio News*.

Gernsback's 1927 proposal was to erect a powerful short-wave transmitter at some point on the globe, with the receiver at its antipodes. Note exact time (2½ seconds) predicted in article written 19 years ago.

for scientific research work, as well as explore our own planet for scientific purposes. He also recognized that to accomplish the feat, short waves would have to be used. The article stated:

"I am fully aware of the criticism that will at once be raised, that it is not possible for us to send a radio beam beyond the confines of our own atmosphere, due to the so-called Heaviside layer, which is supposed to exist a hundred or so miles above the surface of the earth. According to the researches of the eminent scientist, Oliver Heaviside, the upper layers of our atmosphere are so conductive electrically, due to the ionizing effect existing at such heights, that the radio waves are reflected; and it would thus seem impossible that we could shoot a radio beam outside of the confines of the earth.

"This may be perfectly true when it comes to the usual radio waves, such as have been used in the past, varying from some 15 meters up to 25,000 meters. I am equally certain that at lower wavelengths, say from two meters downwards (Note: The Signal Corps scientists actually used wavelengths in the order of two meters, namely 111.6 megacycles), entirely different conditions appear, for the following reasons:

"We know that radio waves are an electro-magnetic activity, the same as light waves or heat waves. It is believed that, the lower down we go in the wavelength scale (that is, the higher the frequency), the easier it becomes to penetrate the Heaviside layer, if we grant its existence at all.

"Radio waves travel at the rate of, roughly, 186,000 miles each second. If observers at opposite sides of the earth were using chronometers, and if a signal were sent from one side at a certain time, the signal going out to the moon and reflected from it would be found to return to the earth in a little more than two and a half seconds. This would afford, therefore, a complete proof of the theory."

COMMENTS ON 1927 PREDICTION

FROM THE FATHER OF RADIO

Mr. Hugo Gernsback
25 West Broadway
New York, N. Y.

I have read with keen interest your ingenious suggestions, made nineteen years ago, of using then-existing means for transmitting ultra-short wave energy to the moon and receiving its reflected signal. In view of the recent actual realization of such transmission by U. S. Army radar your early suggestion assumes startling importance.

Here again is one more amazing instance of the numerous articles written by you in the past, foreseeing, suggesting or prophesying revolutionary advances in the radio or electronic arts. I venture to say that during the ensuing 50 years many more instances of the sort will be recorded to your credit and far-seeing prescience.

The youth of today, interested in the revolutionary progress of science, as most of these must be in view of the war's astonishing developments, should be stimulated by this early and accurate prediction of yours, stimulated to look keenly into Nature and Science, to foresee some of the infinite possibilities there concealed.

(Dr.) Lee de Forest

FROM THE PRESIDENT OF RCA

Mr. Hugo Gernsback
25 West Broadway
New York, N. Y.

It has been interesting to observe your pre-

diction made nineteen years ago of interplanetary radio communication, especially in the light of the fact that a radar signal was recently beamed to the moon and its echo received.

Long-range forecasts in the field of science, although at the time may appear fantastic, often serve as an inspiration and a goal for imaginative young people with an aptitude for science.

Your predictions in wireless and electronics have no doubt awakened ideas in youthful experimenters, and if they have found encouragement in your visionary writings you should be as happy as a teacher who inspires pioneering achievement.

(General) David Sarnoff

FROM THE PRESIDENT OF I.R.E.

Mr. Hugo Gernsback
25 West Broadway
New York, N. Y.

Thanks for your letter of January twenty-eighth and for the very interesting enclosures which came with it.

I know from a small amount of personal experience that one of the very pleasant things in life is to be able to look back to a prediction made years ago and point to the fact that it has come true.

You are certainly to be congratulated for having done this in the article of February, 1927.

F. B. Llewellyn

HARD-TO-GET PARTS

POWERFUL ALL-PURPOSE INDUCTION MOTOR

IDEAL FOR EXPERIMENTERS—101 USES

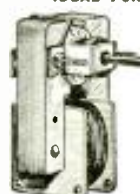

Sturdily constructed to precision standards, this self-starting shaded pole A.C. induction motor is powerful enough for a number of uses. Some of these are: Automatic Timing Devices, Current Interrupters, Electric Fans, Electric Chimes, Window Displays, Photocell Control Devices, Electric Vibrators, Small Grinders, Buffers and Polishers, Miniature Pumps, Mechanical Models, Sirens, and other applications.

Consumes about 15 watts of power and has a speed of 3,000 R.P.M. When geared down, this sturdy unit will constantly operate an 18-inch turntable loaded with 200 lbs. dead weight—THAT'S POWER! Dimensions 5 1/2" high by 2 1/2" wide by 1 3/4" deep; has 4 convenient mounting studs; shaft is 7/8" long by 3/16" diameter, and runs in self-aligning oil-retaining bearings. Designed for 110-230 volts, 50-60 cycles, A.C. only. Shp. Wt. 2 lbs.

ITEM NO. 147
YOUR PRICE \$2.95

ULTRA MAGNET

LIFTS MORE THAN 20 TIMES ITS OWN WEIGHT

LITTLE GIANT MAGNET

Lifts 5 lbs. easily. Weighs 4 oz. Made of ALNICO new high-magnetic steel. Complete with keeper. World's most powerful magnet ever made. The experimenter and hobbyist will find hundreds of excellent uses for this high quality permanent magnet. Measures 1 3/4" x 1 1/4" Shp. Wt. 3 lbs.

ITEM NO. 159
YOUR PRICE \$1.50



GENUINE MICROPHONE TRANSMITTERS



Regular telephone transmitters taken from a large telephone supply company's overstock. Work perfectly on 2 dry cells. Can be used on P.A. systems, call systems, intercommunications, etc., short-line telephone circuits, house-to-house or farm-to-farm phone lines, also to talk through your own radio or as concealed dictaphone pick-up. Useful replacements on battery-operated rural telephone lines.

THESE ARE GENUINE TRANSMITTERS. MADE BY KELLOGG, WESTERN ELECTRIC AND STROMBERG-CARLSON, excellent in appearance and operation. A remarkable value and one seldom offered in these times. Shp. Wt. 1 lb. ITEM NO. 160
YOUR PRICE \$1.50

AMAZING BLACK LIGHT!!

Powerful 250-Watt Ultra-Violet Source



The best and most practical source of ultra-violet light for general experimental and entertainment use. Makes all fluorescent substances brilliantly luminescent. No transformers of any kind needed. Fits any standard lamp socket. Brings out beautiful opalescent hues in various types of materials. Swell for amateur parties, masquerades, etc.; to obtain unique lighting effects. Bulb only. Shp. Wt. 2 lbs.

ITEM NO. 87
YOUR PRICE \$1.95

WESTERN ELECTRIC BREAST MIKE

This is a fine light-weight aircraft carbon microphone. It weighs only 1 lb.

Mike comes with breastplate mounting and has 2-way swivel, ring adjustment so that it can be adjusted to any desired position. There are 2 woven straps; one goes around neck, the other around chest. Straps can be snapped on and off quickly by an ingenious arrangement.

This excellent mike can be adapted for home broadcasting or private communication systems. By dismounting brassplate, it can be used as desk mike.

Comes complete with 6-foot cord and hard rubber plug. Finished in anemurized plate, non-rustable. Shipping weight, 2 lbs.

ITEM NO. 152
YOUR PRICE \$2.55

WATTHOUR METER

Completely overhauled and ready for immediate service. Designed for regular 110-volt, 60 cycle 2-wire A.C. circuit. Simple to install; 2 wires from the line and 2 wires to the load. Sturdily constructed in heavy metal case, 8 1/2" high, 6 1/2" wide, 5" deep. Westinghouse, G. E., Ft. Wayne, Sangamo or other available make. Shp. Wt. 14 lbs.

ITEM NO. 33
YOUR PRICE \$4.95



HUDSON SPECIALTIES CO.

40 West Broadway, Dept. RC-4-46, New York 7, N.Y.

I have circled below the numbers of the items I'm ordering. My full remittance of \$..... (include shipping charges) is enclosed (NO C.O.D. ORDERS UNLESS ACCOMPANIED WITH A DEPOSIT.)

OR my deposit of \$..... is enclosed (20% required), ship order C.O.D. form, NO C.O.D. ORDER FOR LESS THAN \$5.00. BE SURE TO INCLUDE SHIPPING CHARGES.

Circle item No. wanted:
147 159 160 87 152 33

Name

Address Please Print Clearly

City State

RADOLEK

Radio-Electronic Service Parts

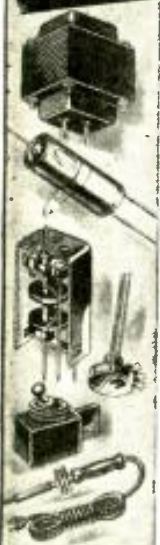

Large stocks assure the finest and most complete selections of all available items at lowest prevailing prices. Thousands of active buyers depend on us for their entire Radio repair and replacement requirements. Because we understand service problems, every order is expedited for delivery in double quick time. Everything we do is planned for convenience and satisfaction to our customers. You will find it profitable to make Radolek your buying headquarters.

FREE BUYING GUIDES

Because of existing conditions we keep our customers right up to the minute on available merchandise by releasing supplements frequently instead of sending our regular Big Profit Guide once a year. Send the coupon now to get these Free Buying Guide Supplements as they are issued.



FAST SERVICE!

RADOLEK CO., Dept. C-113
601 W. Randolph St., Chicago 6, Ill.

Please send FREE Buying Guide Supplements

NAME _____

ADDRESS _____

ORDER FROM RADOLEK

VELOCITY

P.G. DYNAMIC



THE FINEST MICROPHONES AMPERITE FOR PUBLIC ADDRESS & RECORDING

MICROPHONES THAT SURPASS THE HIGHEST REQUIREMENTS OF BROADCASTING, PUBLIC ADDRESS, AND RECORDING

Write for Catalog
AMPERITE COMPANY
561 BROADWAY NEW YORK, N. Y.

A TROUBLE CHASER

(Continued from page 465)

the power supply as a half-wave rectifier. D.c. filtering was accomplished with a 40- and 20- μ f electrolytic condenser and a 2000-ohm 5-watt resistor. Since the trouble chaser is an a.c.-d.c. instrument, the ground clip must be connected so that if one is testing an a.c.-d.c. receiver fuses don't go popping out. This could very easily happen if the receiver chassis was on one side of the power line and the tester on the other side. When the ground clip was clipped on, fireworks would start. To eliminate blowing fuses, a small neon light with built-in resistor is switched in and out.

First plug both the tester and the defective receiver into the power line and place the neon in the ground circuit by plugging the phone tip into the correct plug, touching the test prod to the receiver's chassis. If the neon bulb lights, reverse the power plug to the defective receiver and check again. This time the neon bulb will not light and the phone tip is plugged into the S plug, connecting the ground wire directly to the chassis.

The different phone tips and plugging system are numbered from one through six. In the "S" position the elements are connected as a receiver. The "I" position inputs the incoming signal to jack J1. The test leads consist of 4 feet of rubber cord with a phone plug at one end and an alligator clip and test prod at the servicing end. Also two other small jacks are provided so that the d.c. voltage can be applied to some external source.

Here are a few things to remember when wiring up the tester. Be sure to shield the grid leads that are to be plugged in and out of jacks, such as jacks 2 and 4. This minimizes hum, grid howl and pickup. Also be sure that the speaker is grounded to the metal chassis. Another thing that will also cause the tester to howl or hum is to leave out C2, a by-pass condenser. If this condenser is eliminated, the 50L6-GT tube will oscillate. It is best to check over the wiring circuit about three times before plugging the tester into the power line.

When the unit has been completed and ready for operation, first plug all of the phone plugs into the S position.

Turn on the switch and completely turn on the volume. Wait a few minutes for the tubes to heat up and then rotate the tuning condenser. It is best to attach to an antenna so that a greater number of stations will be picked up. (This little trouble chaser serves as an ordinary radio set as well as locating defective stages in bad receivers.)

Each successive stage can be tested by simply tapping the phone tip associated with that stage with the fingers, to hear hum and noise in the loudspeaker. To further test stages, simply plug in another radio receiver and hook

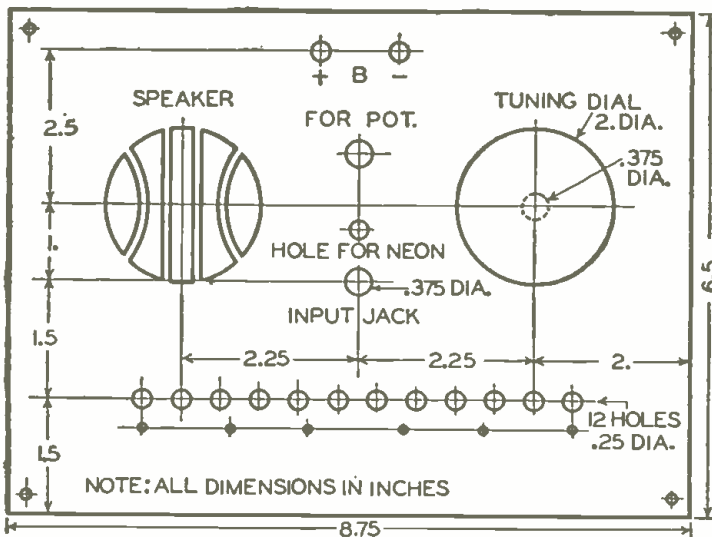
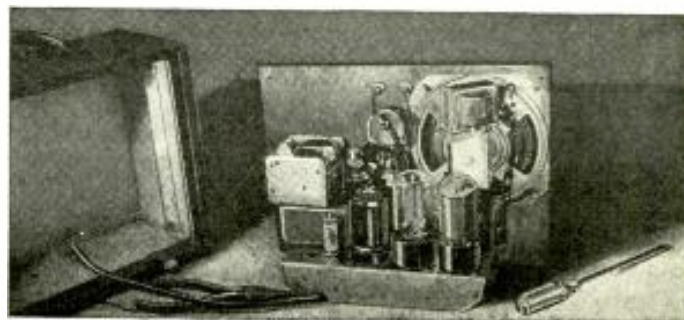

Fig. 2—Working drawing of the panel. This can of course be varied to suit the individual constructor's equipment or taste.

the test leads to the tester. If it is an a.c.-d.c. receiver, be sure and first check the power line polarity with the neon bulb. After this is done, simply clip the ground lead on and use the probe, starting at the antenna coil with plug-tip 2 in the "I" position.

By rotating the receiver's variable condenser stations can be heard. Proceed on down the line through the r.f. and i.f. sections. If the volume is great enough now, use plug-tip number 3 in the input position. The signal will undoubtedly be weaker here but will pick up as you go down the line.

With this signal tester the serviceman can even check output stages, output transformers, and loudspeakers. The results obtained were excellent and speed was encouraging. Many troubles in receivers can be easily tracked down.



A back-panel view, showing placement of parts and chassis layout.

THE OSCILLOSCOPE

(Continued from page 461)

the V-GAIN control advanced. Note the frequency of the stray voltage picked up.

7. Testing of Audio Frequencies can be accomplished by using the a.f. output voltage of a signal generator, (usually around 400 cycles), applied to the vertical input. This can be done much more effectively if the applied a.f. voltage can be controlled.

NOTE: Variation in the amount of a.f. voltage output can be obtained in the "Precision," Model No. E-200-EM, Signal Generator, illustrated in Fig. 4. If a separate audio oscillator is obtainable with its associated controls for output and frequency, it is naturally the most effective means for showing various frequencies.

When the signal generator is set to produce an r.f. wave, modulated at around 400 cycles, and it is connected to the antenna circuit of a radio receiver, the *demodulated audio output* can be observed on the 'scope screen for many useful purposes.

To cite a few examples, it is possible to observe and locate any distortion in the quality of the audio signal being reproduced by the set by first examining the output of the receiver detector, and then proceeding stage by stage through the audio-amplifier tubes up to the loud-speaker. Any departure from the waveform of the injected signal may be traced to its originating section, and may there be identified.

The appearance of certain forms of distortion are easily recognized by comparison with the original sine-wave signal as shown in Fig. 5. The first case, (Fig. 5-c) shows the result caused by a tube that is functioning outside of the linear portion of its characteristic

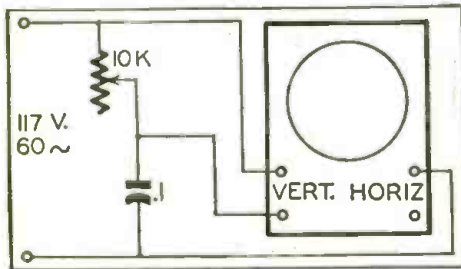

Fig. 6—Circuit to show phase differences.

curve because of overloading. The flattening of the upper half of the wave by saturation of the tube, and the flattening of the lower half of the wave by operating the tube beyond cut-off can be seen clearly. The second screen pattern, (Fig. 5-d) illustrates the appearance of harmonic distortion, which amounts to the introduction of a new frequency (in this case the third harmonic), added to the original sine wave. This effect is often seen when a tube is operating with incorrect bias. Regeneration, as another example, is identified by the ragged shape of the sides of the curve. The ability to recognize instantly such defects goes a long

(Continued on page 506)

ELECTRICIANS! RADIO MEN!

Earn More Money!

Get this new
GIANT SIZE



ELECTRICAL and RADIO TROUBLE SHOOTING MANUAL

GUARANTEED BY COYNE

Yours 10 Days Free

OVER 500
Large Size
Electrical and Radio
Shop Prints
-How to read
and use them

Needed by war workers, maintenance men, beginners, old timers! Nothing else like it. Saves time, helps boost your pay... **4 GREAT BOOKS IN ONE!**

1. New Step-by-Step Trouble Shooting Course. 2. 500 Shop Prints. 3. Electrical Dictionary. 4. Spare Time Jobs.

FREE! 1 yr. Technical Counsel by mail from COYNE staff, on trouble-shooting problems.

SEND NO MONEY! See offer below. Satisfaction guaranteed by famous COYNE "Learn-by-Doing" Electrical School. Rush coupon now!

H. C. LEWIS, President, Dept. 06-T1
COYNE ELECTRICAL SCHOOL
500 S. Paulina St., Chicago 12, Ill.

Send, with all shipping charges paid, your new COYNE Electrical and Radio Trouble Shooting Manual. Within 10 days after getting it I'll either return it or send \$3, then \$3 monthly until total of \$9.95 is paid. Cash price \$9.95 you save over 10%. Same 10-day free trial and return privilege.

NAME _____ Age _____
ADDRESS _____
CITY _____ Zone _____ STATE _____

FREE TRIAL COUPON

LAKE'S RADIO Cabinets & Parts



NOW Available

Postwar
2 Post
RECORD-CHANGER

In luxurious brown leatherette portable case 15" L x 15" W x 10" D. Latest electronic developments make this modern record-changer the finest on the market today!

List Price....\$49.95 Dealer's net....\$29.97

Also blank table cabinets of walnut veneer in the following sizes, with speaker opening on left front side. (Note: 7" has center speaker grill.)

±1	— 8 1/4" L	± 5 1/2" H	x 4" D	\$1.95
±2	— 10 1/4" L	x 6 3/4" H	x 5" D	\$2.75
±3	— 13 1/2" L	x 7 3/4" H	x 6 1/4" D	\$3.25
±7	— 10 3/4" L	x 7" H	x 5 1/2" D	\$2.50

*Speaker Opening in center of front side.

All types of radio cabinets and parts are available at Lake's, lower prices. A large stock is listed in our catalog.

SERVICEMEN—RETAILERS
Join our customer list today.

Write for our NEW, 12 page, illustrated, elaborate catalog! Order from Lake! You'll make no mistake!
Dept. C



LAKE RADIO SALES CO.

615 W. Randolph Street, Chicago 6, Ill.

HOW TO PASS Commercial Radio Operators' FCC LICENSE EXAMINATIONS...

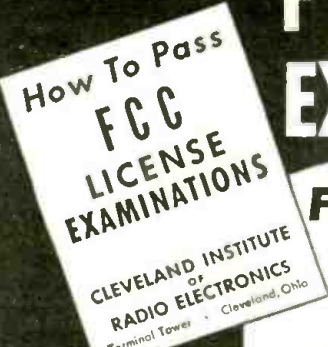

FREE BOOKLET

Tells you the Government Requirements for all classes of commercial licenses. Saves you many hours of random, undirected study. Assures a minimum of time in getting your ticket!

CLEVELAND INSTITUTE OF RADIO ELECTRONICS

Successors to Nilson Radio School, founded 1939;
Smith Practical Radio Institute, founded 1934

RC-4 TERMINAL TOWER

CLEVELAND 13, OHIO

MAIL THIS COUPON

CLEVELAND INSTITUTE OF RADIO ELECTRONICS
RC-4 Terminal Tower, Cleveland 13, Ohio

Gentlemen: Please send your FREE Booklet, "How to Pass FCC License Examinations."

Name

Address

City Zone State

Broadcast stations in the United States have now passed the thousand mark, the FCC reported in December. When normal licensing was resumed on October 8, the number was 961; on December 14 the number reached 1,001.

If a beat-frequency oscillator is needed and unavailable, removal of the receiver's i.f. tube-shields will often provide a satisfactory substitute. If the set uses metal tubes, replacing one of them with a G-type will usually be enough to produce the necessary oscillations.

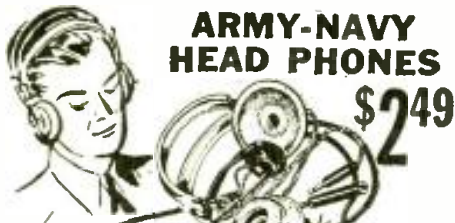

ARMY-NAVY HEAD PHONES

\$2.49

B-A made a lucky buy. Genuine U. S. Signal Corps head phones, highly sensitive, 8000 ohms impedance. Only color magnets. Only \$2.49 a pair plus 20c postage and pkg. chgs. Retail value \$13.50. Order No. 17A37.

FREE Catalog



GET THIS catalog, latest developments in radio and electronic parts and devices, newest ham gear, gadgets and bargains.

BURSTEIN-APPLEBEE CO., 1012 McGee St., Kansas City 6, Mo.

Send me your new FREE catalog.

Send me _____ pairs of phones at \$2.49 plus 20c pair postage. I enclose \$_____ in payment. RC

NAME _____

ADDRESS _____

TOWN _____

STATE _____

Come to the famous

COYNE

TRAINING SHOPS

where you "learn by doing"



TRAIN FOR

RADIO-ELECTRONICS

IN 12 WEEKS

Prepare For A Good Job Now... or for Your Own Radio Business!

Trained Radio-Electronics men needed now. Big future awaits you in Radio Manufacturing, Sound, Television, Electronics. Or you can go in business for yourself—I'll show you how! Learn by Doing on real equipment at Coyne. Free employment service. Many earn while learning. If you are short of money, ask about my Student Finance Plan. Training in Industrial Electronics and Electric Refrigeration at no extra charge. We are also equipped to train those who qualify under G. I. Bill. We also have facilities for men with physical disabilities whether due to war or other causes. Fill in and mail coupon for details.

SEND COUPON FOR FULL DETAILS

H. C. LEWIS, Pres., Radio-Electronics Div. COYNE ELECTRICAL SCHOOL, 500 S. Paulina St., Dept. 46-8H, Chicago 12, Ill.

Send Free Book and details about Coyne Part Time Employment and Student Finance Plan.

Send G. I. Bulletin Physical Disability

NAME _____ AGE _____

ADDRESS _____

CITY _____ STATE _____

speco

PLASTIC PLIERS

- Weighs 1 1/2 ounces!
- Absolutely shock-proof non-magnetic!
- 6,000 volt breakdown!
- Heat resistance 240 to 300 degrees!
- Tensile strength of material, 5000 lbs. per square inch!
- Pick up nuts, screws and washers without danger of shorting!
- Relocate wiring without disturbing magnetic fields while equipment is operating!



\$1.00

DEPT. P-4

ROBERTS ASSOCIATES, P. O. BOX 622, G. C. ANNEX, N. Y. 17

THE OSCILLOSCOPE

(Continued from page 505)

way toward developing dependable methods of locating set defects.

The familiar pictures obtained on the screen by connecting the output of a microphone to the 'scope are additional examples of audio-frequency wave-forms. The use of the microphone gives instructive visual results from a wide variety of sound sources, such as tuning forks, speech and music.

8. Phase Difference Patterns:

(a). For 90° phase difference, a phase-splitting circuit is formed by connecting a variable resistor and capacitor (0.1 mf) across the 60-cycle source. Note in Fig. 6, that the connection between the resistor and capacitor is connected to the ground terminal of the 'scope, and that each end of the 60-cycle voltage source must therefore be ungrounded, since the vertical and horizontal ground terminals of the 'scope are interconnected within the instrument. The elliptical pattern pro-

duced shows the result for a 90° difference in phase angle (also called quadrature). The circular pattern form is produced when the amplitudes of the vertical and horizontal displacements are equal. The forms for other angles of phase difference are shown in Fig. 7.

duced shows the result for a 90° difference in phase angle (also called quadrature). The circular pattern form is produced when the amplitudes of the vertical and horizontal displacements are equal. The forms for other angles of phase difference are shown in Fig. 7.

(b). Zero degree (in phase) condition is produced when the condenser in the phase-splitting circuit is replaced by a resistor. In a similar way, other values of phase angle from 0 to 90°, as shown in the illustration, may be produced by using a variable resistor and condenser combination in place of the condenser alone.

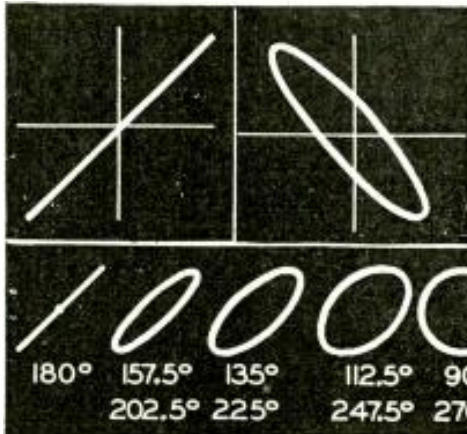

Fig. 7—The various patterns are due to several given angles of phase difference.

(c). Other Wave Forms: It might be well at this point to mention some other methods of showing wave-forms that could, if desired, be the basis of a more detailed study. These might include the following suggestions:

The investigation of the various forms of current present in an a.c. power supply. The formation of elliptical patterns, where the wave-form of the higher of two frequencies is spread out on an ellipse formed by the lower frequency. This method is especially used to com-

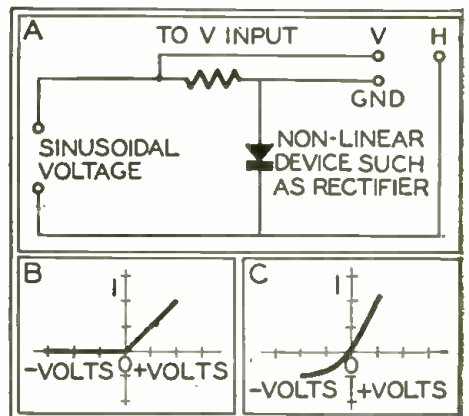

Fig. 8, A—Set-up for producing voltage and current curves. B and C—Curves so produced.

Another article in this series, describing applications of the oscilloscope in the laboratory and shop, will appear in an early issue. The author invites comments from those associated with radio training on further suggestions that might be effective as demonstrations of electronic principles.

¹Schulz & Anderson: "Experiments in Electronics and Communication Engineering."

THE CRYSTAL FILTER

(Continued from page 497)

be only a few cycles wide, some trace of the signal, at least, can be heard over a relatively wide band; and there is little danger of losing the signal completely. After the crystal is cut into the circuit, the final tuning adjustment is simply to bring the signal to the point where the voice or music seems very deep and resonant. As with c.w. operation, it will be well to practice a few times with a dependable signal in order to learn just how the particular receiver in question will act.

Under actual operation in a crowded band of frequencies, there will often be some interfering signal very close to the desired one; and when the desired c.w. or phone signal has been brought to peak crystal response frequency as described above, there may still be some vestige of the interfering signal. The crystal phasing control then steps into the picture. The earlier discussion showed that when the phasing control is moved away from its balanced setting, a frequency of strong rejection appears on one side or the other of the response frequency. Therefore, adjustment of the phasing control makes it possible to almost completely eliminate any particular unwanted signal. It should be pointed out that this phasing adjustment is a final touch, made only after the desired signal has been accurately tuned in.

SELECTIVITY AND GAIN CONTROL

So far, little mention has been made of the receiver selectivity control. Usually, the selectivity will be set *sharp* for i.f. operation with c.w. signals. With crystal operation, however, it will usually be better to have the receiver selectivity set *medium* or *broad*. A combination of sharp receiver i.f. selectivity and sharp crystal selectivity can restrict the band width so much to smear out rapidly keyed signals. This effect is

caused by inability to pass the sidebands necessary for clean keying.

With phone signals, selectivity *must* be held broad if crystal operation is to be used. This is because the phone signals are themselves broad. In many receivers, a special low-selectivity position is incorporated in the crystal switching circuit, marked XTAL PHONE. Even with broadest selectivity adjustments, however, some of the higher frequency components of the audio signal will be cut by the crystal. If additional degrees of selectivity are used, intelligibility will be further reduced. With excessive selectivity, voice signals become a confused mumble of low-pitch grunts.

One other control that occasionally enters into crystal operation is the r.f. gain control. In some receivers, this control affects the oscillator frequency to the extent of a few hundred cycles. With the crystal circuit in operation, this phenomenon is disadvantageous in that it usually requires a readjustment of tuning whenever the r.f. gain is changed appreciably. On the other hand, the r.f. gain control can be used to advantage, within limits, as an extra-fine tuning control for bringing the desired signal just to peak crystal response. This will apply particularly to receivers with inadequate bandspread facilities or excessive backlash in the regular tuning mechanism.

From the foregoing discussion, it should be clear that a crystal filter is not a cure-all for receiver troubles. It has the single advantage of extreme selectivity. It has the disadvantages of reduction in intelligibility of some signals, the necessity for accurate tuning, and greater demands on receiver stability. It takes an understanding of these limitations and an understanding of the basic peculiarities of a crystal circuit to get optimum performance.

NEW RADIO PATENTS

(Continued from page 500)

tube. The latter shunts the field resistance and thus controls the alternator excitation.

V1 rectifies part of the voltage output and R1 constitutes its load. V2 acts in a similar way except that its efficiency is determined by its grid bias, which is made up of a negative battery potential in series with a portion of the positive R1 voltage.

Assume an increase in generator output. All

WHY NOT?

Why not install a spare set of filter condensers in the more elaborate receivers and amplifiers. A simple toggle-switch arrangement can be worked out so that all the serviceman would have to do would be to throw a switch and the radio would have a new set of filter condensers.—*Pvt. John R. Simpson, Miami, Fla.*

(Plug-in condensers, which are commercially available, would seem to be a more practicable arrangement.—*Editor*)

Why not have auto radios fitted with a secret switch so that if anyone but the

owner starts the car and drives away, the radio automatically transmits a constant squawk (on a special band) which the police can easily track by listening to that band on their prowler-car radios.—*William B. Gall, Philadelphia, Pa.*

Why not incorporate an ozone generator (used in eliminating objectionable odors from the air) in a console type radio receiver. The power and space is available, and the additional cost could be much less than the price of a separate unit. It might also improve the reception of the "Soap Operas."—*CPO Guy Deed, Ottawa, Ont.*

for everything in ELECTRONICS and EQUIPMENT follow ARROW!

The New Model CA-11 SIGNAL TRACER

Simple to operate . . . because it has only ONE connecting cable — NO tuning controls!



Signal Intensity Readings Are Indicated **DIRECTLY ON THE METER!**

Features

- * **HIGHLY SENSITIVE**—uses an improved Vacuum Tube Voltmeter circuit.
 - * Tube and resistor-capacity network are built into the Detector Probe.
 - * Comparative Signal Intensity readings are indicated directly on the meter as the Detector Probe is moved to follow the Signal from Antenna to Speaker.
 - * Provision is made for insertion of phones.
 - * **COMPLETELY PORTABLE**—weighs 5 lbs. and measures 5 x 6 x 7 inches.
- Housed in beautiful, hand-rubbed wooden cabinet. Complete with Probe, test leads and instructions. **\$18.75 NET**

Pocket Size MODEL A1

VOLT-OHM-MILLIAMMETER

An Approved Electronic Instrument

A combination of precision, high sensitivity and low cost in a universal meter—an excellent switch-type pocket instrument. Removable leather strap. Size 1 3/4 x 5 1/4 x 3 inches.



\$18.75 NET

Ranges:

DC VOLTS: 15-150-300-1500.
AC VOLTS: 15-150-1500.
MILLIAMPERES: 1.5-15-150.
DC RESISTANCE: 3000-300,000 ohms.

High Impedance HEADPHONES

Made for the
U. S. Signal Corps

Brand new, high quality super-sensitive headphones. Built to rigid government specifications—for service and sturdiness. One of the exceptional values found at ARROW ELECTRONICS COMPANY. Headphones are equipped with Standard Phone Plug.



\$2.45 NET

Write to us for anything in ELECTRONIC PARTS and EQUIPMENT. Get on our mailing list and keep informed as merchandise becomes available.

Please mention Dept. RC when writing or ordering.

ARROW
ELECTRONICS COMPANY
82 CORTLANDT ST., NEW YORK 7, N. Y.
Whitehall 3-2696

**ELECTRONICS WITH
MODERN TEST EQUIPMENT**



Demonstrations

- with
- Multi-meters
 - Signal Generators
 - Oscillographs
 - Radio Kits

BY SOL D. PRENSKY

60 pages of up-to-date, educationally sound electronic demonstrations, illustrated in complete detail. Available to purchasers of test equipment, at no extra cost. Prospective users of multi-meters, signal generators, oscillographs, vacuum-tube voltmeters and radio kits may obtain DEMONSTRATION EXPERIMENT MANUAL EM-C by sending \$2.00, which will be applied as credit to the cost of any test equipment purchased.

Radiolab Publishing & Supply Co.

652 Montgomery Street, Brooklyn 25, N. Y.

Attention!

Introducing
Our First
Post-War
Radio Kit



Ideal for Use By

**STUDENTS • SCHOOLS • HOSPITALS
SERVICEMEN • AMATEURS**

It uses the universally accepted superheterodyne circuit containing the following tubes: 12SA7, 12SK7, 12SQ7, 50L6, 35Z5 and tunes from 550 Kc. to 1600 Kc.

Model S-5 (Illustrated)—Complete Kit, including tubes, Bakelite Cabinet and four pages of diagrams and instructions @ \$19.95

In addition, our previous models of meters and radio kits are still available:

Ohm-Volt Milliammeter Kit M-2 @ \$14.95
Radio Kit model TRF-4A, including tubes @ \$10.95
Radio Kit model S-6, including tubes @ \$17.95

25% Deposit on C.O.D. Orders

We carry a complete stock of parts.

Export Inquiries Invited.

RADIO KITS COMPANY

Dept. M 120 Cedar St. New York 6, N. Y.

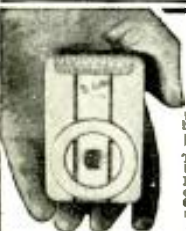

**NEW TINY POCKET SIZE
RADIO!**

Slips in your pocket or purse—Wt. only 3 ozs! Complete, READY TO PLAY as shown with self-contained phone for personal use. Smooth, durable black and silver plastic case. Has patented Fixed Crystal—NO TUBES, BATTERIES OR ELECTRIC PLUG IS REQUIRED. USUALLY RECEIVES LOCAL BROADCASTS CLEARLY without outside aerial wire.

GUARANTEED TO WORK when connected and used according to instructions sent with each radio. Can be used in homes, offices, hotels, cabins, bed, after hours, etc.

SEND ONLY \$1.00 (cash, money order, check) and pay fees on arrival or send \$3.00 for postpaid delivery. IDEAL GIFT FOR CHILDREN OR ADULTS ALIKE! Get your PA-KETTE RADIO TODAY—NOW. Dealers in most cities.

PA-KETTE RADIO COMPANY

DEPT. RC-4 KEARNEY, NEBRASKA

TEST EQUIPMENT

—SHIPPED FROM STOCK!

SUPERIOR CA-11—signal tracer \$18.75
SUPERIOR 400—electronic multimeter 52.50
SIMPSON 260—volt-ohm-milliammeter 33.25
RADIO CITY 802-N—tube & set tester 59.50

25% deposit with order, balance C.O.D.

Also, many other types available.

SCENIC RADIO & ELECTRONICS CO.

53 Park Place New York City 7

LANDINGS BY RADAR

(Continued from page 468)

altitude instructions as well as azimuth corrections. These instructions would sound about like this:

"You are 6 miles from the runway. You are cleared to land 'straight in' on runway 27, northwest 6, ceiling 60 feet. Maintain your present altitude. You are 200 feet to the left of course. Fly right 273."

"You are 5 miles from the runway. Start to descend at 500 feet per minute. . . . You're on course. Fly left 270 to hold your own course."

"You are 4 miles from the runway. . . . 20 feet above the glidepath, adjust your rate of descent. . . . altitude correcting nicely. . . . 10 feet above glidepath. . . . on the glidepath. Your heading is very good."

"You are 3 miles from the runway. . . . on the glidepath. Heading is good."

"You are 2 miles from the runway. . . . 30 feet to the right of course, steer left 267. Check wheels down and locked. You are correcting back on course nicely. . . . You are now 20 feet to the right. . . . 10 feet to the right. . . . now turn right to heading 270 to hold you on course."

"You are 1 mile from the runway. . . . On the glidepath. Heading good."

"You are 1/2 mile from the runway. . . . On the glidepath. Heading very good."

"You're over the edge of the field. . . . On the glidepath. Heading is perfect. You are 20 feet above the runway, which is straight ahead. . . . Touchdown in 2 seconds. . . . Take over from here."

A typical comment of an amazed and relieved pilot who has been brought down in this manner was to breathe a sigh of relief and observe, "So that's Radar Landing Control. Well, that's the best landing somebody else ever made for me!"

This remarkable ability to bring a plane safely and accurately to the glidepath and down on to the runway in bad weather conditions has saved countless lives and hundreds of fighters, bombers and super-bombers in every theatre of war.

Of paramount importance to airline companies, pilots and passengers, and to private pilots as well, is the fact that Radar Landing Control requires *no special equipment in the airplane* except the usual two-way radio communication.

Of equal importance is the fact that with Radar Landing Control the pilot needs *no prior training or periodic practice approaches* to be successfully "talked down" to a safe landing. Finally, because Radar Landing Control operates perfectly in all types of weather and is unerringly accurate under all conditions, a pilot is able to land on split-second schedules with complete assurance and safety.

With Radar Landing Control, commercial airlines will offer greatly improved transportation facilities to the public. In addition, the excessive overhead caused by delayed or cancelled flights will be greatly reduced. Radar Landing Control will increase the margins of safety, dependability and economy, thus assuring wider public acceptance of air transportation. The result cannot help but bring marked increases in revenue and traffic volume, which will lead to a greater expansion of commercial aviation.

For private pilots, the hazardous "weather-permitting" basis upon which their flying has been conducted can now be eliminated. For them, Radar Landing Control will insure safe and dependable year-round flying. The results of this accomplishment can hardly be overestimated.

Radar Landing Control will solve the ever-increasing problem of how to control traffic around congested airports in good weather as well as under conditions of zero-visibility. Through enabling the control tower to direct planes to straight-in approaches in rapid sequence, it will also obviate the necessity of "stacking" planes. Recent tests with all types of planes established the remarkable record of landing them on dual runways at the rate of one every thirty seconds—*120 an hour!* Contrast this to the existing procedure in making instrument landings. With ceiling at 500 feet, planes are landed—without radar—at the rate of four an hour, or *one every 15 minutes.*

Radar Landing Control, which has proved its ability in wartime to land planes under the most adverse weather conditions, is currently being modified by Gilfillan and others, working with the Civil Aeronautics Authority, to make this equipment available soon for use on airports throughout the country.

RADIO-ELECTRONIC QUIZ

How thoroughly have you mastered the contents of this magazine?
Try the following quiz as a test:

1. Who is the present head of the Federal Communications Commission? See page 459.
2. Can a superheterodyne have a fixed oscillator frequency? See page 463.
3. How does the distance between a point on the earth and a point on the moon vary? See page 502.
4. What is a good tube for use as mixer in a superheterodyne where plate voltages are low. See page 466.
5. How would you discover quickly whether a voice coil is open or shorted? See page 472.
6. What are the advantages of the cathode follower in an output circuit. See page 474.
7. What is a ringing oscillator? See page 499.
8. Are microphonic tubes always to be avoided? See page 500.
9. What type of transmitting antenna is quickly variable from unidirectional to bidirectional, and how? See page 509.
10. What is meant by heuristic, and has it any place in the radioman's life? See page 515.

VERTICAL RHOMBICS

(Continued from page 469)

antenna to a capacitive impedance of 70 ohms, and tying the balanced feeder directly to it. This however gives a "dip" in the pattern of the antenna which is very critical and also very disconcerting. Instead of the pattern of 3-a we have that of 3-b. This works satisfactorily except for the fact that two lobes divide the power output, and some of the directional qualities are lost. This for purposes of security is very bad. In using this method, of



Fig. 3—Results of connecting feeder direct.

course, the two ends of the antenna are to be pulled to the same distance, about 2 to 2½ inches apart (some experiment is necessary here for the best spacing).

The second method used gives somewhat better results because it protects the one-lobe directional characteristics of the antenna and helps substantially

inches at one end to 2 or 2½ inches at the other end. Attach the 20-inch end to the 20-inch antenna end and the balanced feeder to the 2½-inch end. Some experimentation is necessary for the correct length of the tapered stub and also for the correct spacing between the two ends of the stub at the small end. A very good ⅜-inch diameter conductor can be made from coaxial cable by removing the insulation between shield and inner conductor at each end of stub and soldering the two together. The complete antenna appears in Fig. 5.

E. The following miscellaneous notes are added for clarification: The rhombic is an unruly antenna and constant maintenance is necessary. Tautness of the wires and cleanliness of insulators is quite critical. Looseness of the wires and a swaying of the mast in the wind causes much amplitude modulated noise, which even the sharpest of limiters cannot eliminate. All metal guys should be eliminated if possible, and if not they should be securely grounded. Under no circumstances should the rhombic be guyed with metallic ropes or wires. Hemp or cotton rope will improve the efficiency 100 percent. A weekly checkup on insulators should be made to remove dirt, grease, corrosion, discoloration, etc.

Much is said about terminating resistors, but very little is done about this problem.

Actually the exact value of terminating resistance has but very little effect on the strength of the field. With no terminating resistor at all, the antenna is bi-directional instead of unidirectional. This may well be kept in mind, as the feature may be useful under certain conditions.

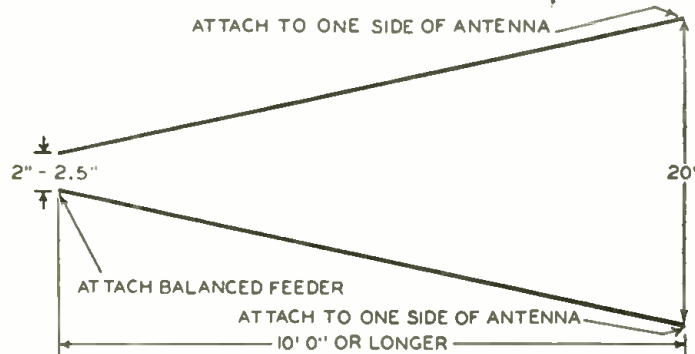

Fig. 4—This device matches impedance between the line and antenna.

to eliminate the back wave in reception. It is somewhat more complicated, employing the delta match or tapered stub system. (See Fig. 4.) Using this method both ends of the antenna are spaced at 20 inches. Using a pair of ⅜-inch-diameter conductors of 10 feet or longer, draw the two down from 20

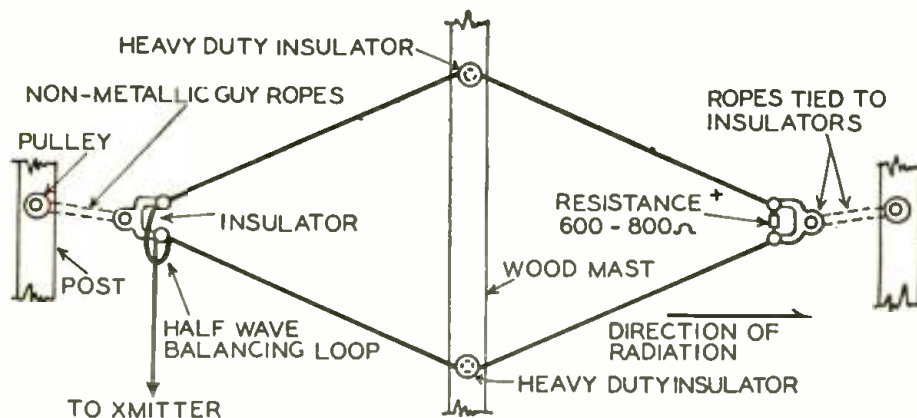

Fig. 5—Appearance of complete antenna. Rhombics have excellent directional characteristics and cover wide frequency bands on wave lengths where they are not impractically big.

WEBSTER

Automatic RECORD CHANGER

\$27²⁰

Here it is—the most perfect—the most dependable record changer Webster has ever built. Its brilliant performance in the armed services proves the superior qualities of Model 56.

Perfectly crafted—highly styled—clean, beautiful lines.

Changes all standard records. Plays ten 12" or twelve 10" records at one loading.

Fast change cycle—approximately 4 seconds.

Simple, fool-proof operation. Can not be "jammed."

Automatic shut-off after last record has played.

Feather light needle pressure.

Longer life for records—no cracks—no chipped edges.

★ ★ ★

Dependable heavy duty Webster motor—cushion mounted for silent operation. No audible rumble or "wow."

Records drop quietly—velvet soft heavy-pile turn-table covering.

Installation done from top—quick, easy mounting.

14-inch square mounting base. Overall depth—above and below mounting board—9 inches.

Built for strength and endurance. Heavy duty plated parts mean lasting performance.

★ ★ ★

PORTABLE CARRYING CASE

This case has overall dimensions that will take any changer. **\$10²⁰**

OUTSIDE DIMENSIONS:

- 16½" WIDE
- 16½" LONG
- 11¾" HIGH

MOUNTING PANEL

- 15¾" x 15¾"

INSIDE DEPTH OF LID 6¾"

RADIO ELECTRIC SERVICE CO.

OF PENNSYLVANIA

N. W. Cor. 7th and ARCH Streets, PHILADELPHIA 6, PA.

BRANCHES

3145 N. BROAD ST., PHILADELPHIA, PA.
5133 MARKET ST., PHILADELPHIA, PA.
811 FEDERAL ST., CAMDEN, N. J.
210 W. 8TH ST., WILMINGTON, DEL.
1042 HAMILTON ST., ALLENTOWN, PA.
9 NORTH SECOND ST., EASTON, PA.



LANGUAGE IS POWER

... Forge ahead, win special assignments, promotion, better job in global peace time opportunities through ability to speak a foreign language.

MASTER A NEW LANGUAGE quickly, easily, correctly by LINGUAPHONE

The world-famous Linguaphone Conversational Method brings voices of native teachers INTO YOUR OWN HOME. You learn the new language by LISTENING. It's amazingly simple; thousands have succeeded.

HOME-STUDY COURSES IN 29 LANGUAGES

Send for FREE book—

LINGUAPHONE INSTITUTE

6 RCA Bldg., New York 20 • Circle 7-0830

LINGUAPHONE INSTITUTE,
44 RCA Bldg., New York 20, N.Y.

Send me the FREE Linguaphone Book.

Name
Address City
Language Interested

DEALERS YOU CAN MAKE A DOUBLE PROFIT THROUGH HANDLING BOOKS

1. BOOKS BRING YOU BETTER CUSTOMERS
They stimulate the interest and knowledge that make steady buyers. The more your customers know about radio the more they will buy from you.

2. BOOKS ARE A PROFITABLE STOCK ITEM
Our trade discounts allow you a good profit on each sale. Our wide promotion insures their sale without effort on your part.

We can supply copy and cuts for your catalog and circulars with your imprint. Write us today for full information on our new radio books, our dealers' discounts and free promotional aids.

The Macmillan Co., 60 Fifth Ave., New York 11
Tech. Bk. Dept.

NATIONAL RADIO PARTS

EXTRA-SPECIAL! By-Pass Condenser Kit—Contains 100 popular sized tubulars .001 to .1 Mfd inclusive. All 600V. Fully guaranteed fresh stock. Per kit\$5.95

AERIAL KITS—Complete. (Individually boxed) 75c

INSULATED RESISTOR KIT—100 most popular sized Deluxe Asst. ¼, ½, 1 Watt R.M.A. color codedPer kit \$2.75

RADIO KNOB KIT—50 Bakelite Set Screw for ¼" shaft. Deluxe Asst. Per kit\$3.95

RADIO KITS—4 tube TRF including tubes. Special\$10.75

Write for Latest Catalog—Just out!

NATIONAL RADIO DISTRIBUTORS

Dept. R. 1029 East 163rd St., New York 59, N.Y.

FRENCH FIRM, selling radio articles in France and North Africa, is looking for representation of an American make of radio, accessories, receivers, tubes, etc. Please write to: Le Materiel-Radiophonique, Service Commercial, 7, Boulevard de Brou, Bourg (Ain), France.

SIGNAL TRACING METHODS

(Continued from page 472)

Although the i.f. and r.f. sections of a receiver can be checked using broadcast station signals, it is always desirable to use a signal generator as the signal source because the frequency modulation and output are controllable. Tune your signal generator to the intermediate frequency of the set under test. Connect the "hot" lead of the signal generator to N, the mixer plate, through a .0001 µf. condenser and ground the other lead. The probe should be touched to this point N to verify the presence of a signal. If phones are used, be sure to modulate the signal generator.

When checking the i.f. amplifier, it is best to start at the signal source N and work your way to the diode R. The probe point is therefore touched to point O, the grid of the first i.f. transformer. If no signal is indicated at this point, check the i.f. transformer. It may be detuned, open or shorted. To check the latter two, use an ohmmeter. To check the former, try retuning. The plate of the i.f. amplifier (P) is checked next. If a low signal is indicated, try retuning the plate winding of the second i.f. transformer Q. No signal points to a defective tube or its associated parts. If a loud signal is indicated at point P, touch the probe tip to R, the diode plates. A low signal at the diode plates R and a loud signal at P, means that the secondary winding S of the second i.f. transformer is out of tune, open or shorted.

The antenna stage is checked in the same manner as the i.f. amplifier of the receiver, using a signal generator or broadcast signals. Place the probe tip to connection X to verify the presence of a signal. If, by touching the probe tip to T a signal is detected, the antenna condenser V is not open. The probe tip is then touched to point U, which is the grid connection of the mixer tube and the stator of the variable condenser. Absence of a signal at this point indi-

cates loss of signal in the antenna coil. It may be caused by either a shorted or open coil or a shorted variable condenser.

To check the oscillator section of the receiver hold the probe tip near the oscillator section of the tuning condenser (stator) Z. It is not necessary to make a direct connection. An indication should be had on the meter. Rotate the tuning condenser. If the indication drops considerably, the oscillator is going out of oscillation and should be checked for a bad tube, bad resistors or bad condensers.

When using a signal generator, always use it with the Modulation "on." This will permit both visual and aural indications. When the signal from a broadcast station is used (tune the receiver to a loud broadcast station), modulation will be shown by a fluctuation of the meter. A steady indication usually means the presence of hum. This is especially true in the audio section.

In all of these tests, either the visual indicator (the meter) or the aural indicator (the phones), can be used. Aural indication is usually more sensitive than visual indication.

The flashlight cells should be changed whenever the "balance-adjuster" control can no longer bring the meter to zero. Polarity should be observed at all times on these, and they should not be allowed to short against each other, or the tube may be damaged. The 45-volt B battery should last a long time with reasonable usage as a total of only two ma is drawn from it by the internal circuit.

While this little tracer cannot, of course, be compared with expensive channel analyzers which use several tubes, tuned circuits and electron-ray indicators, the serviceman may find it well adapted to much of his "outside" work.

A NOVEL AMPLIFIER

(Continued from page 474)

this amplifier, as the output stage has no gain.

The power output will be about 12 watts, and, if more power is desired, it is only necessary to add more 6L6's in parallel. Of course, a larger power transformer will be needed. It will be found, however, that less power will be needed for a given volume because the distortion of this circuit is so low.

Negative feedback is applied between the first and second stages to provide bass and high boost.

Fig. 1 is the circuit diagram, which is straight-forward. The photographs show the proposed layout. It is not necessary to follow it. Any chassis of sufficient size will do, and the only *don't* is that power and output transformers should not be mounted any closer than 6 inches from each other. It is wise

to shield the input wire from the tuner or pickup.

The speaker should be placed in a Bass Reflex enclosure suitable to the size of the speaker, to utilize the remarkable low frequency reproduction of which the amplifier is capable.

Other combinations of tubes can be used, such as 6V6, 6F6 or even triodes, such as the 45, 2A3 and 6A3. These tubes are directly heated, so separate filament transformers will have to be provided to keep from shorting the output transformer.

No matter what output tubes are used, you will be pleasantly surprised at the results. The circuit is rather new, so it leaves plenty of elbow room for the experimenter. Trying different output transformers to get the best match will "pay off" particularly well.

WORLD-WIDE STATION LIST

(Continued from page 478)

Freq.	Station	Location and Schedule
4.990	YV3RN	BARQUISIMETO, VENEZUELA; 6:30 am to 10:30 pm.
5.000	WWV	WASHINGTON, D. C.; U. S. Bureau of Standards; frequency, time and musical pitch; broadcasts continuously day and night.
5.400		BANDOENG, NETHERLANDS INDIES; early mornings.
5.440		MOSCOW, U.S.S.R.; 8 am to 6 pm.
5.580	OAX1B	PUIRA, PERU; 6 pm to midnight.
5.750	PZX3	PARAMARIBO, SURINAM; 6 to 8:45 pm.
5.815		MOSCOW, U.S.S.R.; 11 am to 6 pm.
5.875	HRN	TEGUCIGALPA, HONDURAS; 8 to 10 am; 6 to 11 pm.
5.885	ZRK	CAPETOWN, SOUTH AFRICA; 11:45 pm to 1:30 am; 10 am to 4 pm.
5.890		MOSCOW, U.S.S.R.; 8 pm to 6 am; 8 am to 4:45 pm.
5.895	OAX4Z	LIMA, PERU; 4:30 to 11:30 pm.
5.910	XGOA	CHUNGKING, CHINA; 4 am to 7 pm.
5.940	OAX4V	LIMA, PERU; 6 pm to midnight.
5.947	HH2S	PORT-AU-PRINCE, HAITI; 11 am to 1 pm; 5:30 to 9:30 pm.
5.960		MOSCOW, U.S.S.R.; 11 am to 6 pm.
5.960	FG8AA	POINTE-A-PITRE, GUADELOUPE; 11:30 am to 12:45 pm; 6 to 7:30 pm.
5.968	HVJ	VATICAN CITY; 11 am to noon, 1 to 3 pm.
5.970	VONH	ST. JOHNS, NEWFOUNDLAND; 10 am to 2 pm; 3 to 10 pm.
5.985	LRSI	BUENOS AIRES, ARGENTINA; 7 to 10 pm.
5.997		ANDORRA; 5 am to 7 pm.
6.000	ZFY	GEORGETOWN, BRITISH GUIANA; 5:45 to 7:45 am; 9:45 to 11:45 am; 2:15 to 7:15 pm.
6.000	XEBT	MEXICO CITY, MEXICO; 8:45 am to 12 am.
6.005	CFCX	MONTREAL, CANADA; 7 am to 11:15 pm.
6.005	HP5K	COLON, PANAMA; 7 am to 3 pm; 7 to 11 pm.
6.005	VE9AI	EDMONTON, CANADA; midnight to 2 am.
6.007	ZRH	JOHANNESBURG, SOUTH AFRICA; 11:00 to 2 am, except Saturdays.
6.010	GRB	LONDON, ENGLAND.
6.010	CJXC	SYDNEY, NOVA SCOTIA; 5 pm to midnight.
6.010	OLR2A	P R A G U E, CZECHOSLOVAKIA; midnight to 1:45 am.
6.018	HJXC	BOGOTA, COLOMBIA; 7 to 8 am; 2 to 11:15 pm.
6.020	MCH	LUXEMBOURG; midnight to 3:30 am; 5 to 8:30 am; noon to 6 pm.
6.023	XEUW	VERA CRUZ, MEXICO; 7 am to 12:45 am.
6.023	FZI	BRAZZAVILLE, FRENCH EQUATORIAL AFRICA; 4 to 8 pm; midnight to 1:30 am.
6.025	IRF	ROME, ITALY; 7 to 8:15 am; 12:30 to 6 pm.
6.028		MOSCOW, U.S.S.R.; 5:45 to 9:30 pm.
6.028	ZRH	JOHANNESBURG, SOUTH AFRICA; 11:45 pm to 1:30 am.
6.030	CFYP	CALGARY, CANADA; 7:30 am to 1 am.
6.030	HP5B	PANAMA CITY, PANAMA; 6 to 11 pm.
6.030		BERLIN, GERMANY; 2 to 3 am; 4 am to 1 pm (from Russian sector).
6.035	GWS	LONDON, ENGLAND.
6.037	OLR2B	P R A G U E, CZECHOSLOVAKIA; 4:30 pm to 7 pm.
6.040	WRUW	BOSTON, MASS.; Central American beam, 8:30 pm to 1 am.
6.040		ALGIERS, ALGERIA; 12:30 to 6 pm.
6.040		RANGOON, BURMA; 8:15 to 9:45 pm; 1:15 to 2 am; 6:45 to 8:15 am.
6.040	COBF	HAVANA, CUBA; 8 am to 11 pm.
6.045	XETW	TAMPICO, MEXICO; 7:45 am to 12:45 am.
6.050	GSA	LONDON, ENGLAND; midnight to 12:30 am; 12:45 to 1:30 am; 1:45 to 2:45 am; 3 to 3:15 am; 1 to 6:15 pm.
6.060	WCBN	NEW YORK CITY; Mexican beam, 6:30 pm to 1 am.
6.065		TETUAN, SPANISH MOROCCO; 5 to 6:15 pm.
6.070	GRR	LONDON, ENGLAND; 7 to 10:30 pm.
6.070	CFRX	TORONTO, CANADA; evenings till after midnight.
6.080	WLWK	CINCINNATI, OHIO; South American beam, 7:30 pm to 12:15 am.
6.080	CKFX	VANCOUVER, CANADA; 9:30 am to 3 am.
6.090	GWM	LONDON, ENGLAND.
6.090	LYI	BUENOS AIRES, ARGENTINA; 5:45 to 7:15 am; 5 to 9 pm.

Freq.	Station	Location and Schedule
6.090	ZNS4	NASSAU, BAHAMAS; 7:45 to 8:30 am; 11:30 am to 1:30 pm; 4 to 10 pm.
6.090	CBFW	MONTREAL, CANADA; 7:30 am to 11 pm.
6.095	XRRR	PEIPING, CHINA; 4 to 11 am.
6.095	ZYB7	SAO PAULO, BRAZIL; 4:30 to 10 pm.
6.100	YUD7	DELHI, INDIA; 8:30 to 10 pm.
6.105	PRE9	FORTALEZA, BRAZIL; 3:30 to 6:15 pm Mondays; 3:30 to 8:35 pm other days.
6.110	GSL	LONDON, ENGLAND; North American beam, 9:15 pm to 11:45 pm.
6.120	WOOW	NEW YORK CITY; European beam, midnight to 3:15 am.
6.120	KRHO	HONOLULU, HAWAII; Oriental beam, 4 to 9:45 am.
6.122	HP5H	PANAMA CITY, PANAMA; 6 to 10:30 pm.
6.125	GWA	LONDON, ENGLAND.
6.128	XEUZ	MEXICO CITY, MEXICO; 3 pm to 12:30 am.
6.130	CHNX	HALIFAX, NOVA SCOTIA; 7 am to 11 pm.
6.130	COCD	HAVANA, CUBA; 9 am to 10 pm, sometimes later.
6.130	VPD2	SUYA, FIJI ISLANDS; Sundays, 1 to 5 am; other days, 3 to 4 pm.
6.135	AFRS	MILAN, ITALY; 11:30 am to 4:30 pm.
6.145	HJDE	MEDELLIN, COLOMBIA; 4 to 10:30 pm.
6.150	GRW	LONDON, ENGLAND.
6.150	CJRO	WINNIPEG, CANADA; 9 to 11 pm.
6.150		BELGRADE, YUGOSLAVIA; 1 to 6 pm.
6.155	EQB	TEHERAN, IRAN; 9 am to 2:30 pm; 8 to 8:30 pm.
6.155	TIRH	SAN JOSE, COSTA RICA; 9:30 pm to midnight.
6.155	CS2WD	LISBON, PORTUGAL; 4:30 to 7 pm.
6.160	HJCD	BOGOTA, COLOMBIA; 7 to 8 am; 4 to 11:30 pm.
6.160		MUNICH, GERMANY; midnight to 3 am.
6.160	CBRX	VANCOUVER, CANADA; 6 am to 3 am.
6.165	GWK	LONDON, ENGLAND.
6.165	HHCM	PORT-AU-PRINCE, HAITI; 5 to 8:30 am; 11 am to 2 pm; 5 to 9 pm.
6.165	HER3	BERNE, SWITZERLAND; 1 to 3 pm.
6.180	GRO	LONDON, ENGLAND; 1:30 to 3:30 am; 12:30 to 6:15 pm.
6.180	LRM	MENDOZA, ARGENTINA; 5:15 to 10 pm.
6.190	JLT	TOKYO, JAPAN; home service, 4 to 6 am; 6:45 to 8:30 am.
6.190	HIIA	SANTIAGO, DOMINICAN REPUBLIC; 4 to 5 pm.
6.195	GRN	LONDON, ENGLAND; midnight to 5:15 am.
6.198	HJCT	BOGOTA, COLOMBIA; evenings till 11:30 pm.
6.200	YV6RD	CIUDAD BOLIVAR, VENEZUELA; 5 to 9:30 pm.
6.205	CP5	LA PAZ, BOLIVIA; 6:15 to 10:45 pm.
6.205	FK8AA	NOUMEA, NEW CALEDONIA; 2:30 to 4 am; 4:30 to 5 am.
6.230		MOSCOW, U.S.S.R.; noon to 6:25 pm; 7 to 9:45 pm.
6.235	HRD2	LA CEIBA, HONDURAS; 7:30 to 10 pm.
6.240	HJCF	BOGOTA, COLOMBIA; 5 to 11 pm.
6.243	HIJN	CIUDAD TRUJILLO, DOMINICAN REPUBLIC; 4 to 10:30 pm.
6.280	HCJB	QUITO, ECUADOR; 6 to 10 pm.
6.315	HIIZ	CIUDAD TRUJILLO, DOMINICAN REPUBLIC; 4 to 9:30 pm.
6.330	COCW	HAVANA, CUBA; 7 am to 10 pm.
6.345	HEI2	BERNE, SWITZERLAND; 12:30 to 1:45 am; 2:45 to 7 am; 1 to 5:15 pm; 8:30 to 10 pm.
6.345	COKG	SANTIAGO, CUBA; 4 to 11 pm.
6.357	HRPI	SAN PEDRO SULA, HONDURAS; 6 to 7:30 am; 6:30 to 10:30 pm.
6.370	CSX	LISBON, PORTUGAL; 3:30 to 7 pm.
6.455	COHI	SANTA CLARA, CUBA; 7 am to 1 am.
6.465	TGWB	GUATEMALA CITY, GUATEMALA; 8 am to noon; 6:30 pm to 1 am.
6.485	HI2T	MONSIGNOR NOEL, DOMINICAN REPUBLIC; 4 to 10:30 pm.
6.510	CP40	COCHABAMBA, BOLIVIA; 7:30 to 10 pm.
6.620	TG2	GUATEMALA CITY, GUATEMALA; 6 to 11 pm.
6.715	ZLT7	WELLINGTON, NEW ZEALAND; 4:25 to 4:45 am.
6.720	PMA	BANDOENG, NETHERLANDS INDIES; 5:30 to 9:30 am.
6.750	JVT	TOKYO, JAPAN; to U. S.; 2 to 8 am.
6.760	YNDS	MANAGUA, NICARAGUA; 8 to 10 am; 5 pm to 12 am.

(Continued on page 513)

Highest Quality RADIO & ELECTRONIC TESTING EQUIPMENT

IMMEDIATE DELIVERY from STOCK GUARANTEED

The New Superior Model CA-11 Signal Tracer

Net Price \$18.75



FEATURES:

- * Signal intensity readings are indicated directly on the meter.
- * Only one connecting cable—No tuning controls.
- * Highly sensitive—uses an improved vacuum tube voltmeter circuit.
- * Tube and resistor-capacity network are built into the Detector Probe.
- * Completely portable — weighs 5 lbs. Measures 5 1/2 x 7 inches.
- * Provision is made for insertion of phones.

The New Superior Model 400 Electronic Multi-Meter

Net Price \$52.50



RANGES:

- DC V.T.V.M. Volts: 0 to 3/15/30/75/150/300/750/1500/3000 volts.
 DC Volts: (at 1000 ohms per volt) 0 to 3/15/30/75/150/300/750/1500/3000 volts.
 AC Volts: (at 1000 ohms per volt) 0 to 3/15/30/75/150/300/750/1500/3000 volts.
 DC Current: 0 to 3/15/30/75/150/300/750 Ma. 0 to 3/15 amps.
 Resistance: 0 to 1,000/10,000/100,000 ohms. 0 to 1/10/1,000 megohms.
 Capacity: .0005-.2 .05-20 .5-200 mfd.
 Reactance: 10 to 5M ohms 100-50M ohms 01-5 megohms.
 Inductance: .035-14 .35-140 .35-11,000 henries.
 Decibels: -10 to +18 -10 to +38 +30 to +58

The New Model 705 SIGNAL GENERATOR

Net Price \$49.50



RANGES:

- From 95 kc to 100 mc, continuously variable. Calibration accurate to 2% through broadcast bands, within 3% for high frequency bands. Planetary drive condenser, direct reading calibration, output modulated or unmodulated. Self-contained electronic modulation 400c sine wave available for external use. Special feature provided in having two degrees of modulation at both approx. 30% and 80%.

The New Model 802N Combination TUBE & SET TESTER

Net Price \$59.50



RANGES:

- DC Voltmeter: 0/10/50/500/1000 at 1000 ohms per volt
 Four Range AC Voltmeter: 0/10/50/500/1000
 DC Milliammeter: 0/1/10/100 DC Ammeter 0/10
 DB Meter: 5-8/15/15 to 20/20/7 to 49/32 to 55 decibels
 Four Range Output Meter—same as AC Volts

- | | |
|---|---------|
| R.C.P. Model 447 AC-DC Multitester..... | \$17.95 |
| R.C.P. Model 448 Pocket Multitester..... | \$24.50 |
| R.C.P. Model 461A Sensitive Multitester..... | \$39.50 |
| R.C.P. Model 488 Ultra-Sensitive Multitester..... | \$71.50 |
| R.C.P. Model 668 Electronic Voltmeter..... | \$74.50 |
| R.C.P. Model 805 Tube & Set Tester..... | \$89.50 |
| Supreme Model 546 Oscilloscope..... | \$82.50 |
| McMurdo Silver Model 900 "Vomax"..... | \$59.85 |
| SUPERIOR Model 1553 Volt Ohm Milliammeter..... | \$24.75 |
| SUPERIOR Model PB-100 Volt Ohm Milliammeter..... | \$28.40 |
| SUPERIOR Model PB-210 Multi Meter..... | \$35.75 |
| SUPERIOR Model 450 Tube Tester..... | \$39.50 |
| SUPERIOR Model 720 MultiRange AC Ammeter..... | \$49.50 |

Send for our FREE New Post-War Catalog!

Metropolitan ELECTRONIC & INSTRUMENT CO.

Dept. C, 6 MURRAY STREET
NEW YORK 7, N. Y., U. S. A.
Phone: BARclay 7-5556

Cable Address: METRONICS

ROEHR DISTRIBUTING COMPANY

St. Louis' Radio
Mail Order House

ANTENNAS (Auto and Home)
CONDENSERS
RESISTORS
MICROPHONES
TUBES
PHONO MOTORS
BATTERIES
(All Types
AB Packs)
PHONO NEEDLES
TRANSFORMERS (All Types)
VOLUME CONTROLS
(Complete Stock Carbon
and wire wound)

ALL R. M. S. CABINETS IN
STOCK

Write for our list of tubes
catalog package, and informa-
tion on how to secure a
Speedex Tube Base Chart free
of charge.

ST. LOUIS 3, MISSOURI

OPPORTUNITY AD-LETS

Advertisements in this section cost 20 cents a word for each insertion. Name, address and initials must be included at the above rate. Cash should accompany all classified advertisements unless placed by an accredited advertising agency. No advertisement for less than ten words accepted. Ten percent discount six issues, twenty percent for twelve issues. Objectionable or misleading advertisements not accepted. Advertisements for May, 1946, issue must reach us not later than March 23, 1946.
Radio-Craft • 25 W. B'way • New York 7, N. Y.

MAGAZINES (BACK DATED)—FOREIGN, DOMESTIC, arts, books, booklets, subscriptions, pin-ups, etc. Catalog 10c (refunded). Cicerone's, 863 First Ave., New York 17, N. Y.

AMATEUR RADIO LICENSES, COMPLETE CODE and theory preparation for passing amateur radio examinations. Home study and resident courses. American Radio Institute, 101 West 63rd Street, New York City. See our ad on page 516.

CORRESPONDENCE COURSES AND SELF-INSTRUCTION books, slightly used. Sold, Rented, Exchanged. All subjects. Satisfaction guaranteed. Cash paid for used courses. Complete information and 92-page illustrated bargain catalog free. Write—NELSON COMPANY, Dept. 2-39, Chicago 4.

SURPLUS RADIO AND ELECTRONIC PARTS and equipment. New and used. Write for free list. Highbridge, 312 Canal St., New York City 13.

YOUR NEW FREE CATALOG IS READY! RADIONIC'S Catalog lists hard-to-get radio parts and books. All available for immediate shipment. Send today to: Radionic Equipment Co., Dept. N1, 170 Nassau St., New York 7, New York.

FOR SALE—TUBE TESTER—GOOD CONDITION—Superior 1240. Also Meissner FM Receptor Model 9-1047A. Cash takes offer. Joseph Zukauskas, 2011 No. 3rd St., Philadelphia, Pa.

YOU CAN MASTER MATHEMATICS, KEY TO THE Electronic Age. University School of Mathematics-O, 623 Walter Story Bldg., Los Angeles, Calif.

NOW! DETROLA AUTOMATIC CHANGERS PLAYS 10 12-inch records and 12 10-inch records. Immediate delivery! Price only \$29.87. Order today. GI Jack's Radio Sales & Parts, 119 West Main St., Bellevue, Ohio, Dept. K.

MAGNETS: 4 ALNICO MAGNETS—\$1.00. LIFT 2# to 4#. Satisfaction guaranteed. List free. Ronald Eyrich, 3731 W. Center, Milwaukee 19, Wisconsin.

SAVE MONEY—BIG FREE LIST AIRCRAFT RADIO Equipment: Transmitters BC 430, 457, 458, etc., \$50 & up. Receivers BC 429, 455, 348, etc., \$50 & up. Big stock Dynamotors varied sizes, Hand Mikes, Headphones, Coils, Amplifiers and hundreds other items at prices never heard of before. **Big Free Sales List.** Send card to E. "Tex" Helm, 319 South Canon Street, Carlsbad, New Mexico.

COMMUNICATIONS

ARE AMERICAN RADIO REPAIRMEN SPOON-FED?

Dear Editor:

The radio industry in this country differs from that in America in a number of respects, one of them being in the matter of technical approach to service problems. In this country, it is more or less in the ordinary day's work that the serviceman has to convert a receiver from a.c. to a.c.-d.c., or perhaps from a.c. to 32 volt vibrator. The high initial cost of radio receivers makes this worth while from the radio owner's point of view. Obviously, work of this nature involves rapid manipulations of Ohm's Law anyway, and sometimes of far more complicated problems. Exact replacement parts *have hardly ever been available* in this country, likewise circuit diagrams of some receivers, but radio servicemen here have met the problem by making themselves fully conversant with basic principles, and the broad principles of radio design.

To be candid, I believe American radio servicemen have been spoon fed. They have had unlimited technical information on the receivers they service, and they have had—in many cases anyway—easy access to exact replacement parts. I base my opinion on personal contact with American radiomen out here with

the Armed Forces, and also on the endless articles on the problem of substitution which have filled American radio magazines in the war years. Substitution became a necessity in America when parts became short, but in this country it was done even in normal times.

The article by I. Queen on tube replacements, which is presumably read eagerly by American radiomen, and which is also nothing but an elementary application of Ohm's Law as applied to heater circuits, will be passed over here as neither interesting nor informative.

I recall a job which came in during the early part of the Pacific war—a Zenith if I remember correctly—from one of the American boats in port here. The set was suffering from one or two minor troubles, but in the back of the cabinet was a note written on the letterhead of a Pacific Coast radio store. Believe it or not, the note apologized for not re-aligning the receiver while it was in for repair, *because the manual for that model was not available!* The alignment was well out, the set was re-aligned, and as far as I know there is still no manual here for that particular receiver.

E. B. MENZIES,
Auckland, New Zealand

READER DOESN'T LIKE RADAR ARTICLES

Dear Editor:

Just a few lines to say that I formerly enjoyed your magazine, when you printed CONSTRUCTIVE articles, diagrams, etc. It seems that now all you print is articles on GERMAN RADAR and equipment of destruction. Don't you think people have heard enough of WAR. Some have lost their sons in this war and want to forget it. Why keep it fresh in everyone's mind? Are we to continue to be on a wartime basis from now on, even in our reading matter? Why keep us reminded of it? Why not something that we can use in peacetime pursuits? I for one am fed up with war—war—and continued talk of WAR!

CONTENTS: Radio Fuze Fires Shells . . . U. S. Carrier Radar . . . German Radar . . . Elements of Radar . . .

Is that all you know, War instruments?

J. GRANT,
Olney, Okla.

(Mr. Grant forgets one important point. During the war, for security reasons, no articles on radar or many other electronic inventions could be published. It is the duty of every technical magazine to keep their readers informed now that restricted war information is available.

Another and more important point: Mr. Grant would be the first one to condemn *Radio-Craft* if it did not publish such information—a *great deal of which is applicable to peacetime uses!* There is hardly any electronic-radio war invention which in some way or other will not be used for peace in the near future.—Editor)

CANADIAN NICKEL HAS TWELVE SIDES

Dear Editor:

I wish to take this opportunity to correct an error which appeared in the December, 1945 edition of *Radio-Craft*.

On page 189 of this issue, you show a picture of a 1945 series Canadian 5-cent piece, enlarged to show the code message around its edge.

In the explanation below the picture you state that it was issued "just before the end of the war." While that statement may be true for the 1945 coin pictured, it is not true that that was the first Canadian 5-cent piece bearing

the code message. While I am not certain in which series of nickels the message first appeared, I first saw the message on a Canadian nickel four years ago.

You also state that "the coin is also original in that it is eight-sided instead of round." I think that a closer inspection of the coin will reveal that it is 12-sided rather than 8-sided.

J. COPLAND
Ottawa, Canada

(We noticed that twelve-sided feature, too—after the magazine was printed! —Editor)

WORLD-WIDE STATION LIST

(Continued from page 511)

Freq.	Station	Location and Schedule
6.770	CP49	LA PAZ, BOLIVIA; 7 to 9 am; 11 am to noon; 6:30 to 9 pm.
6.850	YNOW	MANAGUA, NICARAGUA; 8 am to midnight.
6.910	YNQW	MANAGUA, NICARAGUA; 8 to 10 am.
6.980	FO8AA	MOSCOW, U.S.S.R.; 5:45 to 6:25 pm; 7 to 9 pm; 11:15 to 11:45 pm.
7.008	YNBH	PAPEETE, TAHITI; Fridays and Saturdays, 10 to 11:30 pm.
7.010	XPSA	MANAGUA, NICARAGUA; 6 to 10 pm.
7.018	YNWW	KWEIYANG, CHINA; 11:30 pm to 1 am; 5 to 10 am.
7.065	GRS	GRANADA, NICARAGUA; 1 to 10 pm.
7.080	H12A	LONDON, ENGLAND; 12:15 to 5:30 pm; 11 pm to 3:30 am.
7.100		SANTIAGO, DOMINICAN REPUBLIC; 10 am to 1:30 pm; 4:30 to 8:30 pm.
7.100		BISSAU, PORTUGUESE GUINEA; 5 to 5:30 pm.
7.120	GRM	LONDON, ENGLAND; 1 to 3:45 am; 2:30 to 4 pm; 5 to 8:30 pm.
7.140		VIENNA, AUSTRIA; midnight to 2 am; 6 to 8 am; 10 am to 4:30 pm.
7.150	GRT	LONDON, ENGLAND; midnight to 12:15 am; 2 to 2:30 am; 6 to 7:15 am; 7:30 to 8:45 am; 11 to 11:30 am; noon to 12:30 pm; 1 to 2:30 pm; 3 to 4:45 pm; 5 to 8:30 pm.
7.153	XGOY	CHUNGKING, CHINA; 6:30 to 10:30 am.
7.160	HCIBF	QUITO, ECUADOR; 6:45 to 11 am; noon to 2 pm; 5 to 11 pm.
7.160		VIENNA, AUSTRIA; midnight to 2 am; 6 to 8 am; 10 am to 8:30 pm.
7.185	GRK	LONDON, ENGLAND; 2 to 5 pm, 6 to 10:45 pm.
7.190	JCPA	CAIRO, EGYPT; 3 pm to 7; 10:30 pm to midnight; 2 to 3 am.
7.205	GWL	LONDON, ENGLAND; 6:30 to 8:45 am, 10 to 10:30 am, 11 am to noon, 4:15 to 5:30 pm, 8:15 pm to 12:15 am.
7.210	FGY	DAKAR, FRENCH WEST AFRICA; 1:15 to 1:45 am; 2 to 2:30 am; 1:45 to 4:25 pm.
7.215	FG8AH	POINTE-A-PITRE, GUADELOUPE; 6 to 7:30 pm.
7.215	VLQ2	BRISBANE, AUSTRALIA; 2:30 to 8:30 am.
7.215	EAQ	MADRID, SPAIN; heard 9:30 to 10 pm.
7.220	JCKW	JERUSALEM, PALESTINE; 10:30 pm to 3 pm.
7.220		SINGAPORE, MALAYA; 11:30 pm to 1:30 am; 3:30 to 5 am; 5:30 to 10:35 am.
7.230	GSW	LONDON, ENGLAND; 3:30 to 5 pm; 9:30 to 11:45 pm; 1 to 3:30 am.
7.230	KWID	SAN FRANCISCO, CALIF.; Oriental beam, 6:45 to 11 am.
7.250	KGEX	SAN FRANCISCO, CALIF.; Philippine beam, 5 am to noon.
7.250	PJCI	WILLEMSTAD, CURACAO; 11:45 am to 12:15 pm; 3 to 4:30 pm.
7.253	GW1	LONDON, ENGLAND.
7.260	GSU	LONDON, ENGLAND; 2:30 to 3:30 pm; 4:15 to 11:45 pm.
7.260	JVW	TOKYO, JAPAN; Home service, 3 pm to 8:30 am.
7.265		MUNICH, GERMANY; 11 pm to 2 am; noon to 4 pm.
7.275	VUD8	DELHI, INDIA; 6 to 7 am; 11:15 am to 1:15 pm; 6:30 to 7:15 pm; 9 to 10 pm.
7.280	GWN	LONDON, ENGLAND; midnight to 12:30 am; 12:45 to 1:15 am; 1:45 to 2:45 am; 3 to 3:15 am; 6 to 8:30 am; 11 am to 12:30 pm.
7.280	VLA	MELBOURNE, AUSTRALIA; 7:45 to 10 am; 10:15 to 10:45 am.
7.285	JLG	TOKYO, JAPAN; home service, 4 to 8 am.
7.290	VUD3	DELHI, INDIA; 7:30 to 10:30 am; 9 to 10 pm.
7.295	ZOY	ACCRA, GOLD COAST; off at 1 pm.
7.300		MOSCOW, U.S.S.R.; noon to 5 pm; 6:15 to 11:30 pm.
7.315	YSN	SAN SALVADOR, EL SALVADOR; 1 to 3 pm; 7 to 11 pm.

A fluorescent lamp for radio sets produces "black light" which transforms the dial markings into glowing colors. The tube, which is expected to burn five years without replacement, is manufactured by Westinghouse.

33 well overlapped ranges . . .

plus long-life dependability!



WESTON

(Model 665 Type 1)

VOLT-OHM-MILLIAMMETER

Its compactness, versatility and rugged dependability make Model 665 the ideal instrument for use in the field, or in the shop . . . whether servicing communications equipment, testing electrical components in production, or research or maintenance work. Provides 33 AC and DC voltage, DC current, and resistance ranges . . . with simplified switching arrangement for rapid operation. Built to WESTON standards to assure dependable measurement accuracy throughout the years. Full details on request. Weston Electrical Instrument Corporation, 599 Frelinghuysen Avenue, Newark 5, N. J.

WESTON Instruments

CASH FOR

SERVICE SHOP PHOTOS

Radio-Craft wishes to obtain photographs of good Service Shops. Send us a photo of your shop, together with a description to help us evaluate the picture. We will pay three dollars for each excellent snapshot, and five dollars for each professional photograph accepted. Photos not accepted will be returned at once.

Radio gyps are active in Montreal, according to a statement by an official of the Canadian Wartime Prices and Trade Board, in a warning to the public to deal only with reputable radio firms when either purchasing a set or having one repaired.

A number of complaints have been received from owners who have had their sets taken away by "repairmen" who failed to return the sets. Calls at the supposed addresses of the repairmen revealed that they had moved, apparently after having disposed of the receivers. Other owners allege exorbitant prices for simple repair jobs; or that they have been sold sets inferior to their old receivers—for which they received trade-in allowances as partial payment on the "new" sets.

famous for

GREAT VALUES

Special...NOW!

Crystal Kit \$1.97

5-Tube SUPERHET \$15.50

Complete with Cabinet and Tubes but excluding wire and solder.

6-Tube SHORT WAVE KIT \$15.50

2 1/2 to 12 megacycles. Battery operated, complete with Metal Cabinet and Tubes, but excluding wire and soldering. Overall size, 7 1/2" x 4 1/4" x 2 1/2".

All prices are F.O.B. New York City

Also: Test Equipment • Replacement Cabinets • Vibrators • Electrolytics (all kinds) • Tubes • Transformers • Soldering Irons • Radio Kits • Ham Supplies, etc.

We ship anywhere in the U.S.A.—promptly!

WRITE FOR OUR CATALOG NOW!

**RADIO DEALERS
SUPPLY COMPANY**

135 LIBERTY ST., NEW YORK 6, N. Y.

There's a new kind of
AMPLIFIER
a-coming!
— and A. C. Shaney
is "a-fixin' to build it"
at Amplifier Co. of America

Technicians want a better kind of amplifier . . . and they are going to get it! For there is an amplifier in the making at Amplifier Co. of America today, that promises to revolutionize the industry's thinking about the amplifier of the future. It is cleverly designed, beautifully constructed and most amazing in its performance. Its fundamental design is one of the truly exciting secrets of our time. New circuits, new materials, and new processes combine in this amplifier to achieve a triumph of modern engineering.

It may not be the first amplifier off the line, but it may well be the first completely new one. And amplifier men know that A. C. Shaney and his associates at Amplifier Co. of America have what it takes to build the kind of an amplifier that engineers, technicians and music lovers are waiting for.

That's why so many thousands today are "watching the news" from

AMPLIFIER CO.

of **AMERICA**

398 BROADWAY, NEW YORK 13, N. Y.

A postal card will put you on our mailing list to be among the first to know.

INDEX TO ADVERTISERS

Adson496
Aerovox Corp.494
Allied Radio Corp.....485
Amperite Co.....504
Amplifier Co. of America.....514
Arrow Electronics Co.....507
Audel & Co., Theo.....484
Bell Telephone Labs.....482
Buffalo Radio Supply Co.....500
Burstin-Applebee Co.....506
Cannon Co., C. F.....515
Capitol Radio Eng. Institute....477
Centralab Co.....452
Cleveland Institute of Radio 490, 505
Concord Radio Corporation....487
Coyne Electrical School 495, 505, 506
Crabtree Wholesale Radio.....496
Deacy, W. H.....496
DeForest's Training, Inc.....453
General Cement Mfg. Co.....496
General Electric Co.....501
Hallicrafters Co., Inc.....451
Hudson Specialties Co.....503
International Resistance Co....479
Lake Radio Sales Co.....505
Le Materiel Radiophonique.....510
Liberty Radio Sales Co.
 Inside Back Cover
McElroy, T. R.....515
McMurdo Silver Corp.....491
Macmillan Co., The.....510
Metropolitan Electric Instrument Co.....511
Miles Reproducer Co.....500
Murray Hill Books.....492, 493
National Plans Institute.....515
National Radio Distributors.....510
National Radio Institute.....445
National Schools.....454, 455
Newark Electric Co., Inc.....495
Ohmite Manufacturing Co.....489
Onan & Sons, D. W.....499
Opportunity Adlets.....512
Pakette Radio Co.....508

Panoramic Radio Corp. Back Cover
Pioneer Sound Co.....497

RADIO SCHOOL DIRECTORY
(See Page 516)

American Radio Institute
Candler System
Cleveland Institute of Radio
Commercial Radio Institute
Lincoln Engineering School.
Mechanics Training School
Melville Radio School
RCA Institutes, Inc.
Linguaphone Institute.....510
Radio Dealer's Supply Co.....514
Radio Distributing Co.....496
Radio Electric Service.....509
Radio Ham Shack.....496
Radio Kits Co.....508
Radiolab Publishing Co.....508
Radio Product Sales Co.....497
Radio Publications.....515
Radio & Television Supply Co.515
Radio Wire Television, Inc.....502
Radolek Co.....504
Raytheon Manufacturing Co.....446
Roehr Distributing Co.....512
Roberts Associates.....506
Rosicrucians500
Scenic Radio & Electronic Co...508
Solar Mfg. Co... Inside Front Cover
Sound Equipment Co.....495
Sperry Gyroscope Co.....447
Sprayberry Academy of Radio...449
Superior Instrument Co.....483
Supreme Publications.....481
Sylvania Electric Prods. Co....448
Taybern Equipment Co.....496
Terminal Radio.....499
Triplett Elec. Instrument Co...456
Weston Elec. Instr. Co.....513
World Radio Laboratories.....498
X. L. Radio Labs.....515

A 32-VOLT RECEIVER (Continued from page 466)

resistor is not objectionable in a regular a.c. receiver, but was eliminated here to keep gain at a maximum.

The 6R7, transformer coupled, was found best for the first amplifier tube, as the combination of medium-mu and transformer coupling proved better than a high-mu tube with resistance coupling at the low voltage available. The 6R7 is normally diode-biased, but in this circuit a bias cell was found necessary. One Mallory cell was used. It must not be shorted or it will lose its voltage. Moist fingers affect it, and it must not be checked, except with a vacuum-tube voltmeter.

Appearance of the 32-volt receiver is better than that of many commercial receivers.

THE OUTPUT STAGE

The power output stage consists of two 25L6 tubes in pushpull. These are biased by a 50-ohm resistor in the cathode circuit. No cathode by-pass condenser is necessary as no signal voltage should be present. Tone quality of the output stage is satisfactory so long as the supply
(Continued on page 516)



BOOK REVIEWS

HOW TO SOLVE IT, A New Aspect of Mathematical Method, by George Polya, Stanford University. Published by the Princeton University Press. Stiff cloth covers, 5½ x 8 inches, 204 pages. Price \$2.50.

This little book—not written for the radioman—contains much that may be of value to him. Devoted to the art of solving problems, it refers largely to mathematical ones, of which many arise in radio. Its real value is that it gives in a systematic manner the rules for *solving problems in general*; putting into exact terms—and sequence—methods most of us have more or less followed in a vague and instinctive way.

An interesting feature of the book is that the greater part of it is presented alphabetically, under the name "A Short Dictionary of Heuristic (the science of solving problems)." The "dictionary" so-called does not consist of isolated entries, but forms a well-worked-out and connected text on the subject.

A synopsis of the whole method, with the main rules, appears on the inside front cover and facing page, and is duplicated in the back of the book.

RADIO TUBE VADE-MECUM (with titles also in French, German and Holland). Edited by P. H. Brans. Published by the Algemeene en Technische Boekhandel, Prins Leopoldstr. 28, Antwerp, Belgium. Heavy paper covers, 7½ x 10½ inches, 208 pages. Price 105 Belgian francs (approximately U.S. \$2.00).

This four-language "tube manual" is probably the most complete and authoritative set of tube data in existence. It is divided into seven sections, classifying and cross-indexing all American and European tubes.

The first section, of 106 pages, gives the characteristics of more than 2500 types of tubes. British terms are used in describing the tubes. The second table includes a number of rarer tubes, mostly British, not commonly met with on the Continent. Table III lists equivalent types, of which there are many in Europe, where each manufacturer may use his own type numbers for identical tubes.

Table IV is a wartime "tube replacement" list. A number of symbols are used to indicate what changes must be made to replace a given tube with another, whether the new one is more or less efficient than the old, and whether the change is reversible. A very large number of European-American substitutions is given in this table.

Table V consists of nineteen pages of tube-base diagrams, Table VI lists the characteristics of Russian tubes (not listed in the other tables due to the Russian-alphabet designations) and Table VII is a list of military tube numbers and their civil equivalents.

The manual is complicated, and a search for a given tube entails considerable page turning. Extensive instructions are, however, given in four languages, and the radioman should have little difficulty in getting the information he wants, as soon as he has mastered the markings of symbols sufficiently to get the "feel" of the book.

PRINCIPLES OF RADIO, by Keith Henney. Published by John Wiley & Sons, Inc. Stiff cloth covers, 5½ x 8 inches, 534 pages. Price \$3.50.

This fifth edition of Principles of Radio contains new information on FM, UHF phenomena and UHF theory in the last two chapters. The rest of the text, covering some 443 pages, is strictly similar to the fourth edition. Triodes are still favored in ninety percent of the diagrams though the majority of tubes used today are tetrodes, the pentodes, dual (twin) tubes, or in the special purpose class.

Mr. Henney assumes that the reader has some knowledge of physics and a capability for understanding text matter without long-winded, drawn-out, analogies. The pace of the book is fast, and numerous mathematical examples are given to illustrate each theory without invading the beachheads of calculus.

The usually blank inside front and back covers and facing fly leaves are utilized to good purpose in presenting data and charts on average characteristics of receiving tubes, wavelength/frequency conversion charts, and a table of trigonometric functions.

The theoretical context is excellent
(Continued on following page)

RADIO TERM ILLUSTRATED



Suggested by: John Cavanaugh, Cohoes, N. Y.

Headset Headquarters

GUARANTEE CANNON-BALL

Phones to give absolute satisfaction. Unusually sensitive. Noted for fidelity and clarity of tone. Folder R-4 illustrates Complete Cannon-Ball line. Write

C. F. CANNON COMPANY
SPRINGWATER, N. Y.

Get Started in Radio



10 "HOW-TO-DO-IT" BOOKS

Get a solid foundation in radio by means of these 10 timely text books. Each clearly written, profusely illustrated, contains over 15,000 words. You'll be amazed at the wealth of information packed into these handy books. Excellent for reference—ideal for technical library. Your money back if not satisfied.

5 BOOKS for 50c
10 BOOKS for \$1.00
Sent to You Postpaid

- | | |
|--|-------------------------------------|
| No. 1—How To Make Four Dozier Short Wave Sets | No. 6—How To Have Fun With Radio |
| No. 2—How To Make The Most Popular All-Wave 1 and 2 Tube Receivers | No. 7—How To Read Radio Diagrams |
| No. 3—Alternating Current for Beginners | No. 8—Radio for Beginners |
| No. 4—All About Aerials | No. 9—Simple Electrical Experiments |
| No. 5—Beginners' Radio Dictionary (Leading Terms) | No. 10—Television |
- Remit by check or money order—register letter if you send cash or stamps.
RADIO PUBLICATIONS, 25A West 87th St., New York (7)

BE YOUR OWN BOSS! MAKE MORE MONEY



\$1.00 VALUE

25c

68 PAGES

40,000 WORDS

In "CASH IN" you get ALL the real money-makers—dozens of profitable tested mail order plans, confidential business secrets, dozens of practical tested formulas, successful tested schemes—actual experiences of men who have started on a shoestring—with less than \$10 capital. 25c a copy postpaid. Send U. S. stamps, money order, or coin.

MONEY BACK GUARANTEE
NATIONAL PLANS COMPANY
P. O. Box 26R, Station N New York 23, N. Y.

Do you need BINDING POSTS?

The XL PUSH POST with its Spring Action assures Constant Contact and quick connection.

Manufactured in All Aluminum Type M at 12c each.

Aluminum Body, Bakelite Top Type M! at 15c each.

Types CP or MP, ALL BRASS—STAINLESS STEEL SPRING & PIN. PROVEN by 240 HR. SALT SPRAY TEST as NON-CORROSIVE at 28c each.

Manufacturers and Dealers Liberal Discounts

X. L. RADIO LABORATORIES
420 West Chicago Ave., Chicago 10, Ill.

Ted McElroy

World's Largest Manufacturer of Wireless Telegraphic Apparatus

COMPLETE CENTRAL OFFICE EQUIPMENT

McElroy Manufacturing Corp.
82 Brookline Avenue • Boston, Massachusetts

In the Rocky Mountain Region it's

RADIO & TELEVISION SUPPLY CO.

150 Hubson Ave., P.O. Box 892
PUEBLO, COLO.

"If we don't have it, we'll get it—
or it can't be had! Phone 5729"

RADIO SCHOOL DIRECTORY

PREPARE NOW FOR SKILLED JOBS IN RADIO AND ELECTRONICS

MAKE a place for yourself in a new world of radio and electronics—a world in which revolutionary electronic developments will require highly specialized technical knowledge. Take a good course now to fit yourself for a good paying job. The training you need can be supplied by one of the schools advertised in this publication.



RADIO

Train with professionals. Complete, intensified courses: Repair & Maintenance, Communications, High-Speed Telegraphy, Slip transcription, FCC exams, etc.

High School Students accepted for training as Merchant Marine Radio Officers.

Gov't sponsorship available to veterans.

"A Radio School managed by radio men."
45 W. 45th St., Dept. RC, New York 19, N.Y.

MELVILLE RADIO INSTITUTE



RCA INSTITUTES, Inc.

Offer thorough training courses in all technical phases of

Radio and Television

DAYS—EVENINGS WEEKLY RATES

VETERANS: RCA Institutes is approved under G. I. Bill of Rights

For Free Catalog Write Dept. RC-46

RCA INSTITUTES, Inc.
A Radio Corporation of America Service
75 VARICK STREET NEW YORK 13, N. Y.

COMMERCIAL RADIO INSTITUTE
A radio training center for twenty-four years.

RESIDENT COURSES ONLY

Broadcast, Service, Aeronautical, Television and Marine telegraphy classes now forming. Literature upon request. Veteran training. Classes now forming for mid-year term. Dept. C, 38 West Biddle St., Baltimore 1, Md.

Correspondence Courses in

RADIO and ELECTRICAL ENGINEERING

ELECTRICAL ENGINEERING Get good grasp of wide electrical field. Prepare yourself, at Low Cost, for secure future. Modern, simplified, you can understand quickly.

RADIO ENGINEERING Get into radio, photo-electric work, photo-electric address, photo-electric work.

Trains you to be super-service man, real vacuum tube technician. Servicemen needed badly. Diploma on completion. Tuition \$25, either course. Deferred payment plan.

Get copies of school catalogs, student magazines, complete details. SEND NOW!

FREE

LINCOLN ENGINEERING SCHOOL Box 931C-86,
Lincoln, Nebr.

BOOK REVIEWS

(Continued from previous page)

for the instructor or independent student. This book was used in training both military and civilian radio personnel during the war, since the author gives the reader "just enough and not too much." The entire text is expertly balanced; the author employs a judicious use of diagrams and analogies, liberally sprinkled with theory and peppered with a few pinches of mathematics, making a more-than-passable radio dish—E.A.W.

A 32-VOLT RECEIVER

(Continued from page 514)

voltage does not fall below 29 volts. A noticeable dropping off in quality starts at that point, and becomes very serious if the voltage falls much further.

Some experimenting was done with

CODE SENDING
RECEIVING SPEED



Be a "key" man. Learn how to send and receive messages in code by telegraph and radio. Commerce needs thousands of men for jobs. Good pay, adventure, interesting work. Learn at home quickly through famous Candle System. Write for FREE BOOK.

CANDLE SYSTEM CO.
Dept. 3-D, Box 928, Denver 1, Colo., U.S.A.

RADIO

RADIO Technician and Radio Communications courses. Register now for new classes starting first MONDAY of each month. Day and Evening Classes.

AMERICAN RADIO INSTITUTE
101 West 63rd St., New York 23, N. Y.
APPROVED UNDER GI BILL OF RIGHTS.

START YOUR OWN REFRIGERATION REPAIR SHOP!

Exceptional opportunity for men of all ages up to 60 who like to work with tools. Learn to be a service mechanic in REFRIGERATION. Our practical, thorough home training is easy to grasp in your spare hours with a common school education. Learn how to start your own business with \$50.00 worth of tools in garage, basement or small shop. Or take a well paid job in this active field.

FREE Booklet

• Write for FREE BOOKLET today.

MECHANICS TRAINING SCHOOL
2717 So. Broadway Dept. C-4 Los Angeles 3, Calif.

RADIO

Home Study Courses for Radio Technicians and Radio Engineers. Prepare now for a better Radio-Electronics job. Free Booklet. See our large ad. on pages 411 and 415.

Cleveland Institute of Radio Electronics
RC-4 Terminal Tower Cleveland 13, Ohio

fixed bias, but more undistorted output was obtained with the system shown.

The output transformer was of the universal type. Various taps were tried till the combination which sounded best to the ear was found. A tone control consisting of a 50,000-ohm potentiometer and an .04 μf condenser was put across the plates of the power stage.

The four 6.3-volt tubes are connected in series with a 20-ohm resistor—across which is placed a No. 47 pilot light—and put across the line. The 25L6's connected in parallel and in series with a 10-ohm, 5-watt resistor form another branch across the line, as shown in the diagram.

A PM speaker was tried instead of the electrodynamic type shown, the idea being to save current. The electrodynamic speaker gave better results than any of the PM's tried and as the drain was only 70 ma, it was adopted.

The filter consists simply of a dual 40-μf electrolytic condenser. The common negative lead is cut off and the condenser connected as indicated in the

schematic. The unit now has no polarity. This is important because the radio may be plugged into the d.c. line backward. This would ruin a polarized condenser, but has no effect on this circuit other than to render the receiver inoperative till the plug is reversed. The power factor of the dual condenser is rather high, and a 0.1-μf paper condenser is shunted across it to by-pass the r.f. currents.

Another advantage of this circuit is cheapness. Lack of power supply and filter circuits bring the cost down to a very low figure.

Radio Thirty-Five Years Ago

In Gernsback Publications

HUGO GERNSBACK
Founder

Modern Electrics	1908
Electrical Experimenter	1913
Radio News	1919
Science & Invention	1920
Radio-Craft	1929
Short-Wave Craft	1930
Wireless Association of America	1908

Some of the larger libraries in the country still have copies of Modern Electrics on file for interested readers.

From the April, 1911, issue of MODERN ELECTRICS:

The Fontana (wireless) Mast.

The "Singing Spark" System of Wireless Telegraphy.

Underground Wireless.

New (Arc) Apparatus for Wireless.

High Power Transmitting Condenser, by *Elmer J. Lamb*.

Galena, by *Austin C. Lescarbours*.

A Rotary Tuning Coil, by *C. J. Sedlak*.

Leyden Jar Condenser, by *John B. Brady*.

How to Make an Exhausted Coherer, by *Fannon Beauchamp*.

A Watch Case Detector, by *Louis C. Aldrich*.

A "Batteryless" Telegraph, by *Edward Hutchinson*.

Tuning Transformer, by *Wallace Ells*.

Record Breaking Buzzer Transmitter, by *J. P. Camgros*.

Portable Receiving Outfit, by *Lewis C. Mumford*.

Another Aerial Switch, by "Fips."

Portable Wireless Outfit, by *H. McCabe*.

New Loose Coupler, by *Robert Karlowa*.

A Portable Wireless Telegraph Outfit, by *Richard H. Foster*.

Drones loaded with explosives more powerful than TNT were used to destroy U-boat pens which could not be destroyed by other means. The guided projectiles were no small devices like the radio target planes described recently but were full-size Flying Fortresses, loaded with explosives to maximum capacity and guided by radar and television to their targets.

Liberty RADIO and PHONOGRAPH Kits...

6 Tube "Super Het" Radio Kit

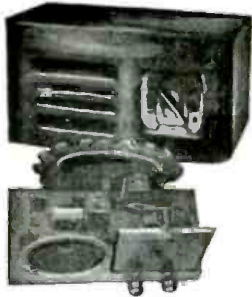

COMPLETE, INCLUDING ATTRACTIVE WALNUT CABINET — Diagram Furnished
All Parts Mounted
 To assemble, all one needs is a soldering iron and 30 minutes of your time.
 Uses one 25L6—one 25Z6—one 6SQ7—one 6SK7—two 6SJ7
Your Cost — \$16.95
 LESS TUBES

5 Tube "Super Het" Radio Kit

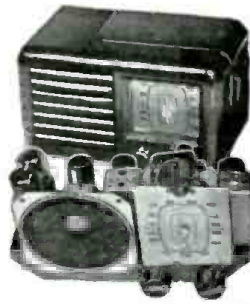

COMPLETE, INCLUDING ATTRACTIVE BROWN BAKELITE CABINET.
 Diagram Furnished — All Parts Mounted
 APP SIZE 9x5x6 Inches—Uses one 25L6—one 25Z6—one 6SA7—one 6SQ7—one 6SK7.
Your Cost — \$13.95
 LESS TUBES

Portable Phonograph Kit



ATTRACTIVE ALLIGATOR COVERED CABINET
 COMPLETE WITH MOTOR — PICK-UP — AMPLIFIER
 SIZE: 14 x 7½ x 19
 Uses one 25L6—one 25Z6—one 6C5.
 TONE AND VOLUME CONTROLS
Your Cost — \$28.95
 LESS TUBES

TERMS: 10% DEPOSIT WITH ORDER

Special Buys for the Amateurs and Industrials

SPECIAL HIGH VOLTAGE MICA CONDENSERS

C.D. MICA CONDENSERS .02 — 600 V. WKGU D.C. TEST 1000 V. D.C. — Your Cost .12 cts.
 C.D. MICA CONDENSERS .0004 — 2500 V. WKGU D.C. TEST 5000 V. D.C. — Your Cost .19 cts.
 C.D. MICA CONDENSERS .0001 — 600 V. WKGU D.C. TEST 1000 V. D.C. — Your Cost .12 cts.

GENERAL ELECTRIC PYRANOL BASE MOUNTING — 1 MFD. — 500 Volts WKG. — Your Cost \$.65
 GENERAL ELECTRIC 2.0 MU-F — 600 V. D.C. BASE MOUNTING. — Your Cost 1.10
 SPRAGUE — 4 MFD — 600 V. D.C. OIL UPRIGHT: Size (2½ x 1¼ x 4) BASE MOUNTING. — Your Cost 1.59
 CORNELL DUBILIER — 8 MFD — 500 V. WORKING UPRIGHT ALUMINUM CAN. — Your Cost .95
 CORNELL DUBILIER OIL — 10 MFD — 600 V. D.C. BASE MOUNTING. — Your Cost 2.10
 CORNELL DUBILIER — 15 + 15 MFD — 450 V. W. TUBULAR — Your Cost 1.10
 AEROVOX OIL COND. IN CAN — .5 MFD — (Size: 1½ x 1 x ¾") — Your Cost .29
 CORNELL DUBILIER OIL COND. IN CAN — 10 MFD 50 W.V. (Size 1¾ x ¾ x 1) — Your Cost .34
 SWITCHES TOGGLE TYPE PUSH TO MAKE — Your Cost .14
 SPECIAL CLOSE OUT G.E. METER MODEL 40ARB17 Reading 2.5—0—2.5 M.A.—
 25—0—25 M.A. Two Readings — Your Cost 3.95

Attention: RADIO AMATEURS

SPECIAL VOLUME CONTROLS — NO SWITCH
 2½ INCH SCHAFTS "STANDARD BRANDS"
 1 meg — 200 M — 100 M — 500 M — 250 M — 60 M — 50 M
 40 M — 20 M — 15 M — 10 M — 5 M — Your Cost .18 cts. ea.
DUAL VOLUME CONTROLS — NO SWITCH
 10 M + 5 M / 100 M + 100 M / 10 M + 75 M / 20 M +
 20 M / 80 + 1000 — Your Cost .28 cts. ea.

"SPECIAL" — OIL BATHTUB CONDENSERS
 ALUMINUM CAN
 .05 MFD — 600 V. — Your Cost .08 cts.
 3 x .05 MFD — 300 V. D.C. — Your Cost .19 cts.
 1.2 MFD — 600 V. — Your Cost .14 cts.
 3 x 2.2 MFD — 600 V. — Your Cost .39 cts.
 15 MFD — 35 VOLTS WORKING — Your Cost .16 cts.

SPECIAL — IMMEDIATE DELIVERY — "PORTABLE BATTERIES — "FARM PACKS"
 Manufactured by Nationally Known Manufacturer — "FULLY GUARANTEED"

FARM "A" BATTERY				
Stock No.	Voltage & Type	Size	List	Your Cost
782	1½ Volt "A", 90 Volt "B"	16x4½x6¾	6.25	4.35

PORTABLE "B" BATTERIES				
Stock No.	Voltage & Type	Size	List	Your Cost
330	45 Volt "B"	4-1/16x2½x5¾	1.50	1.05
430	45 Volt "B"	3-7/16x2¼x4½	1.50	1.05
530	45 Volt "B"	1¾x2¾x4½	1.60	1.10
830	45 Volt "B"	3½x1-11/16x5¾	1.50	1.05
545	67½ Volt "B"	1¾x3½x6½	2.20	1.60

PORTABLE "A" BATTERIES				
Stock No.	Voltage & Type	Size	List	Your Cost
111	1½ Volt Unit Cell	2¾x1¼	.10	.06
114	1½ Volt "A"	2½x2½x3¾	.60	.42
116	1½ Volt "A"	3¾x2½x3¾	.85	.59
118	1½ Volt "A"	3-13/16x2¾x5¼	1.00	.70
123	4½ Volt "A"	3¾x4-9/16x1¼	.55	.385
118L	1½ Volt "A"	10¾x3¾x1¾	1.10	.77
118SL	6 Volt "A"	10¾x3¾x1¾	1.10	.77
115S	7½ Volt "A"	3-3/16x1¾x7	.80	.57

10% WITH ORDER — BALANCE C. O. D.

LIBERTY SALES CO., INC.

115 WEST BROADWAY
 NEW YORK 13, N. Y.
 BArlay 7-6063

ENTIRELY NEW . . . FOR THE AMATEUR

PANORAMIC RECEPTION with the . . .

PANADAPTOR

A "MUST" for modern radio shacks!



NOW AVAILABLE AT LEADING
RADIO PARTS JOBBERS

Model PCA-2. Amateur
net price, complete with
tubes and accessories,
for 115V. 60~ operation.

\$9975

One year guarantee against
defects in parts or workmanship
(excluding tubes). Full operating
instructions and maintenance man-
ual furnished with each PAN-
ADAPTOR.

PANORAMIC RECEPTION enables SIMULTANEOUS VISUAL reception of many
radio signals, continuously selectable from a broad band of frequencies down
to a single frequency.

NOW FOR THE FIRST TIME . . . with the PANADAPTOR connected to your
receiver you can see up to 200kc of the band at once.

The PANADAPTOR will . . .

- Select QRM-free spots for sending and listening.
- Provide automatic visual and aural monitoring over a band of frequencies up to 200 kc.
- Locate stations whose exact frequencies are not known.
- Enable observation of other fellow's frequencies in three-way or round robin QSO's—acts as an additional tunable receiver.
- Spot replies to your CQ's.
- Provide instantaneous signal strength ("S") meter for CW and PHONE.
- Simplify frequency setting and station monitoring.
- Facilitate netting operations.
- Assist in making adjustments of transmitters and antennas.
- Enable identification and interpretation of transmitter characteristics (your own and others)
 - CW . . . key clicks, noise, frequency shift.
 - PHONE . . . modulation percent, distortion, carrier shift and splatter, spurious supersonic and R.F. parasites.
 - FM . . . frequency deviation, AM on FM, modulation monitoring

Partial List of PANADAPTOR Features . . .

Easy, simple connection to all receivers with any IF from 450kc to 470kc.

Shows up to 200kc of continuous Radio spectrum at once.

Sensitivity equal to, or better than, receiver.

Six types of operation: Panoramic—visual, aural, visual-aural (Automatic Monitor). Tunable Unisignal—visual (modulation, signal check, etc.), aural (additional receiver), visual-aural.

Audio output jack.

Four simple operating controls.

Does not affect normal operation of receiver.

Clear, sharp Panoramic picture in normally lighted room.

Non-walking rubber feet.

Sturdy steel cabinet and chassis plus high quality components and workmanship assure long life and trouble-free operation.

Panel and cabinet finished in standard black or grey satin wrinkle to harmonize with the rest of your rig.

Overall dimensions: 11" wide, 9-3/8" deep, 4-3/16" high.

Ask your dealer
for free demon-
stration or write
to us for descrip-
tive booklet.

PANORAMIC

CABLE ADDRESS
PANORAMIC, NEW YORK



RADIO CORPORATION

246 WEST 55TH ST. New York 12, N.Y.